

PD2-6200/PD2-6300

Helios Dual-Line 6-Digit Flow Rate/Totalizers



PD2-6200

HELIOS

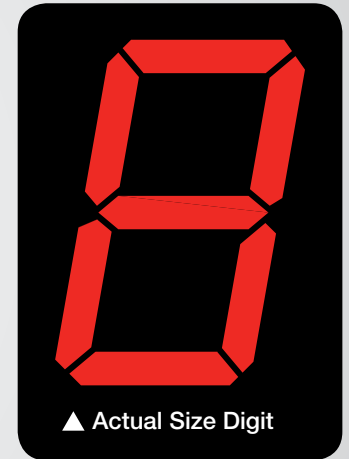

FLOW RATE/TOTAL

COMMON HELIOS METER FEATURES

- Large 1.80" Digits
- Dual-Line 6-Digit Display
- Readable from up to 100 Feet (30 Meters) Away
- Superluminous Sunlight Readable Display
- NEMA 4X, IP65 Rated Field Mountable Enclosure
- Operating Temperature Range of -40 to 65°C (-40 to 150°F)
- Isolated 24 VDC Transmitter Power Supply
- Universal 85-265 VAC, or 12-24 VDC Input Power Models
- Onboard USB & RS-485 Serial Communications
- Modbus® RTU Communication Protocol Standard
- Program the Meter from a PC with Onboard USB and MeterView® Pro

COMMON RATE/TOTALIZER FEATURES

- Display Rate & Total at the Same Time
- Rate in Units per Second, Minute, Hour, or Day
- Total, Grand Total or Non-Resetable Grand Total
- Password Protection for Total Reset
- 9-Digit Totalizer with Total Overflow Feature

- Total Stored in Non-Volatile Memory
- Any Relay for Rate or Total
- 4-20 mA Output for Rate or Total
- Sampling Relay

ANALOG INPUTS

- 0-20 mA, 4-20 mA, 0-5 V, 1-5 V, and ± 10 V Inputs
- Open Channel Flow with Programmable Exponent
- Square Root Extraction
- 32-Point Linearization

PULSE INPUTS

- Pulse, Open Collector, NPN, PNP, TTL, Switch Contact, sine Wave (Coil), Square Wave Inputs
- 5, 10 or 24 VDC Flowmeter Power Supply
- Gate Function for Rate Display of Slow Pulse Rates
- K-Factor, Internal Scaling, or External Calibration

PRECISION DIGITAL CORPORATION

**PRECISION
DIGITAL** 
www.predig.com

PD2-6200/PD2-6300 Helios Flow Rate/Totalizers

NEMA 4X, IP65
Rated Enclosure



UV Resistant
Sunlight Readable Display



▲ PD2-6200 Shown



PERFECT FOR FLOW APPLICATIONS

The Helios PD2-6200 and PD2-6300 are multi-purpose, easy to use, large-display rate/totalizers ideal for flow rate, total, and control applications. These flow rate/totalizers are particularly well-suited for flow applications because they can display flow rate and flow total at the same time, provide power to drive the flowmeter, and display flow total, flow grand total, or non-resettable flow total on up to nine digits.

KEY FEATURES

Superluminous Sunlight Readable Display

The Helios' standard SunBright display features extraordinarily bright LEDs. It is perfect for applications where the meter is in direct sunlight or in applications where visibility may be impaired by smoke, fog, dust, or distance.

Totalizer Overflow Displays Total to 9 Digits

These flow rate/totalizers can display up to nine digits of total flow with the total overflow feature. In the diagrams below, the flow totalizer is displaying 532,831,470 by toggling between a display of "oF 532" and "831470". Notice the (T with arrow ▲ symbol) is lit up indicating the display is in overflow mode.



Display Flow Rate, Total or Grand Total

The upper display can be programmed to display flow rate, total, or grand total, and the lower display can be programmed to display flow rate, total, grand total, engineering units, custom legends, or can be turned off. Both displays could also display relay set points, or max and min values. The following examples show typical ways these flow rate/totalizers can be programmed.



Flow Rate Indicator



Flow Totalizer



Rate & Total



Total & Grand Total

Precise, Accurate, and More Informative

The Helios' large 1.8" display provides a highly accurate and precise dual line, 6-digit view of the process measurement. Its 24-bit A/D is accurate to $\pm 0.03\%$ of calibrated span ± 1 count.

Easy to Program

The user friendly dual-line display makes the PD2-6200 easy to set up & program with its programming buttons located behind the front door panel. There are three levels of password protection to help maintain the integrity of the programming and there are no jumpers to set for the meter input selection.



Input Setup

Display Setup

Three Tier Password Protection

The PD2-6200 and PD2-6300 offers 3 levels of password protection:

- Level 1 protection allows the operator use of only the 3 pre-configured function keys without a password.
- Level 2 protection allows the operator use of only the function keys and the ability to change set points without a password
- Level 3 protection restricts the operator from using the function keys and all meter configuration menus without a password.

On-Board Digital Inputs and Outputs

The PD2-6200/PD2-6300 includes five (5) digital inputs and four (4) digital outputs standard. Since the Helios is a large display meter it is often mounted in areas where it is not convenient to access the programming buttons. The digital inputs can be set up to mimic the four programming buttons on the Helios meter, thus making it possible to mount remote buttons for programming in a more convenient location. In addition, the digital inputs can also be used to reset the total, operate the tare feature, reset the tare, and more. The digital outputs can be used to drive alarming devices or as a means to communicate alarm conditions with a PLC.

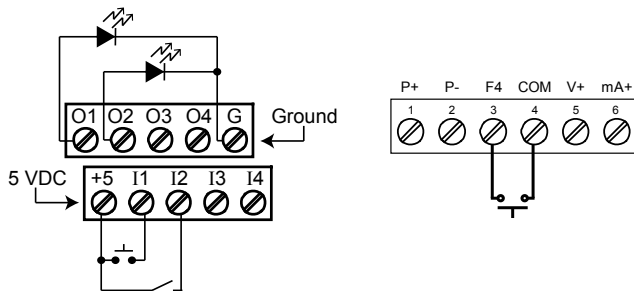

Configurable

The upper display can be programmed to indicate PV, maximum (peak), minimum (valley), alternating maximum/minimum, one of four alarm set points, or Modbus input. The lower display can also be configured to display engineering units, set points, user defined legends, or simply turned off.

Rounding

The rounding feature is used to give the user a steadier display with fluctuating signals. It causes the display to round to the nearest value according to the rounding value selected (1, 2, 5, 10, 20, 50, or 100). For example, with a rounding value of 10, and an input of 12346, the display would indicate 12350.

Function Keys

There are three function keys available to the user. These keys can be programmed to trigger certain events (i.e. acknowledge alarms, reset max and/or min, disable/enable output relays, or hold current relay states), provide direct menu access points, and more.

Max/Min Display

Max/Min (or Peak/Valley) is standard on the PD2-6200/PD2-6300. Either display can be configured to show either maximum or minimum excursion since last reset. The displays can also be configured to toggle between Max and Min values. Any of the F1-F3 function keys (buttons) and the digital inputs can be programmed to reset the max & min readings.

Free USB Programming Software

The Helios comes with free programming software that connects to your PC with a standard USB cable that is provided with each instrument. A new and very useful feature of this software is that it is resident on the Helios meter and installed directly into your PC. This eliminates the need to install drivers or download software from the internet. Just connect the Helios to your PC (the Helios even gets its power from the PC so you don't have to provide external power!) and within minutes you will be programming it with the free software.



TOTALIZER CAPABILITIES

Helios' flow rate/totalizers can be programmed for a wide variety of totalizer applications. They can display total, grand total, or non-resettable grand total with a time base of seconds, minutes, hours or days. The user can program a totalizer conversion factor, a non-resettable grand total, password protection, and several total reset methods.

Totalizer Password Protection

The total and grand total can be password protected so they can be reset only by authorized personnel. The user can also set up the grand total to be non-resettable by entering a specific password. Once this is done, the grand total can never be reset.



Total Password

Grand Total Password

PD2-6200/PD2-6300 Helios Flow Rate/Totalizers

Totalizer Conversion Factor

The user can enter a totalizer conversion factor that allows the meter to display total in different units than the rate. For instance, a customer could measure flow rate in gallons per minute and total in hundredths of acre-feet.

Remote Total Reset

Using the Helios' on-board digital inputs the PD2-6200 and PD2-6300 can be programmed to reset the total or grand total. Digital inputs are made via a push button or switch connection to the appropriate digital input connector block and the +5 VDC block.

Total Alarms

The Helios' 2 or 4 internal relays can be set up to alarm when the total reaches a user-defined set point. A variety of reset modes are available and the user can also program time delays and fail-safe operation.

Function Keys Total Reset

The three function keys located behind the front panel door can be programmed to reset the total and grand total. This makes it possible for the user to reset either the total or the grand total by pressing the appropriate function key. Of course, if the total or grand total is password protected, they will not reset when the function key is pressed.

DIGITAL COMMUNICATIONS

Modbus® RTU Serial Communications

With onboard RS485 serial communication, the Helios PD2-6200 and PD2-6300 can communicate with any Modbus *master* device using the popular Modbus communications protocol that is included in every Helios. This greatly increases the flexibility of the meter. Modbus provides much more capability than read PV and write set points. Below are some examples of other things that can be done with the meter's Modbus communications.

- Send a 6-character message to the lower display upon an event
- Convert a digital value to a 4-20 mA signal
- Remote user control (i.e. change set points, acknowledge alarms)
- Input a Modbus digital PV (in place of analog input)
- Remote override of any, or all, relays and analog outputs



Modbus PV Input



Remote Message

METERVIEW® PRO SOFTWARE

Configure, monitor, and datalog a PD2-6200 and PD2-6300 from a PC using MeterView Pro Software (available with each Helios meter via USB or for download at www.predig.com).



OUTPUTS

Relay Outputs

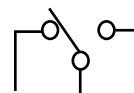

The PD2-6200 and PD2-6300 are available with four 3 A Form C relays (SPDT) with multiple power loss fail-safe options. Relays can be configured for proper protective action upon input loop break. Relay ON and OFF delay times are user adjustable. Up to four front panel indicators show alarm and/or relay state. All relays can be configured for 0-100% deadband.

Relay Operation/Configuration

There are powerful relay functions that can be configured in the Helios meter, including:

- Automatic reset only (non-latching)
- Automatic + manual reset at any time (non-latching)
- Latching (manual reset only)
- Latching with clear (manual reset only after alarm condition has cleared)
- Pump alternation control (automatic reset only)
- Sampling (activated for a user-specified time)
- User selectable fail-safe operation
- Relay action for loss (break) of 4-20 mA input signal
- Time delay (on and off), independent for each relay
- Manual control mode
- Interlock relay mode

Analog Output

The isolated analog retransmission signal can be configured to represent the rate/process variable (PV), total, grand total, maximum (peak) value, minimum (valley) value, the value for any of the four relay set points, manual setting control, or Modbus input. While the output is nominally 4-20 mA, the signal will accurately accommodate under- and over-ranges from 1 to 23 mA.

Manual Output Control

Take control of any output with this feature. All relays can be forced ON or OFF, and the 4-20 mA output signal can be set to any value within its range. When the relays and 4-20 mA output are controlled manually, an LED labeled "M" is turned on and the associated Alarm LEDs (1-4) flash every 10 seconds indicating that the meter is in manual control mode.

Isolated Transmitter Power Supplies

A powerful 24 V @ 200 mA power supply is a standard feature on the Helios meter. It can be configured for 5, 10, or 24 V (default) by means of a simple internal jumper (see manual). An additional power supply (24 V @ 40 mA) is standard with the 4-20 mA output option.

Sampling Function (PV Triggered Timed Relay)

The sampling function allows the operator to set a set point for a "sampling" relay. When the process (rate or total) reaches that set point, it will close that relay's contacts for a preset period of time (0.1 to 5999.9 seconds). An example of its use may be for wastewater sampling. When the wastewater total reaches a preset total interval (i.e. every 10,000 gallons), the relay contacts would close for a preset time, and by some means (light, horn, etc.) alert someone to take a sample, or provide the trigger to automatically take a sample of the wastewater (see "Open Channel Flow" chart on page 5). The utility of this function can, of course, be expanded beyond sampling and be used whenever a timed relay output closure is required when the rate or a total interval reaches a certain set point.

PD2-6200/PD2-6300 Helios Flow Rate/Totalizers

Interlock Relay(s)

This function allows a process to use one or more very low voltage input signals or simple switch contacts to control the state of one or more internal "interlock" relays. A violation (i.e. loss of input, open switch, or open circuit) forces one or more N/O interlock relay contacts to open. One input can be used in series with a number of interlock switches, or up to four inputs can be required to force-on one (or more) internal interlock relays. Please see *Safety Interlock on the ProVu Series* whitepaper on our website for more information. Requires use of on-board digital I/O.

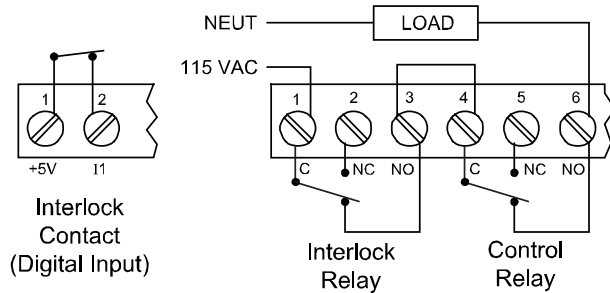

APPLICATIONS

Differential Pressure Flow

The PD2-6200 can display flow rate and total by extracting the square root from the 4-20 mA signal from a differential pressure transmitter. The user selectable low-flow cutoff feature gives a reading of zero when the flow rate drops below a user selectable value.

- Display Flow Rate
- User Selectable Low-Flow Cutoff
- Only 2 Calibration Points Required

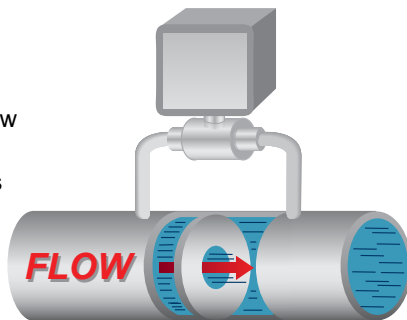

Convert Pulse to 4-20 mA with PD2-6300

The PD2-6300 accepts the pulse output from a flowmeter and with the appropriate option installed can convert the pulse to a 4-20 mA signal. The 4-20 mA signal can be programmed to correspond to either the flow rate or the total flow.



- Use K-Factor or Multi-Point Scaling
- Helios Powers the Flowmeter
- Display Flow Rate & Total

Open Channel Flow

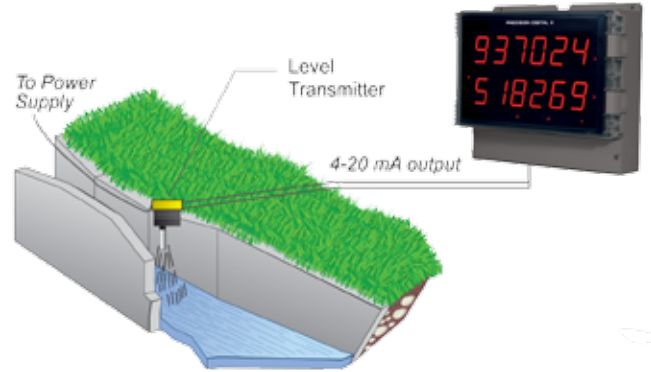

The PD2-6200, in combination with an ultrasonic level transmitter, makes for an economical way to measure and display open channel flow rate and total in most weirs and flumes and take periodic samples. All the user needs to do is enter the exponent for the weir or flume into the PD2-6200 and the PD2-6200 automatically raises the input signal to that power. Sampling can be based on the total flow or the flow rate. See example below:

Function	Desire	Programming
Open Channel Flow	3" Parshall flume	Set Programmable Exponent to 1.547
Flow Rate	Millions of Gallons per Day (MGD)	Set 4 mA = 0 & 20 mA = 3.508 Time base = Day
Total	Millions of Gallons	Set Totalizer Conversion Factor = 1 (password protect total reset)
Non-Resettable Grand Total	Program meter so grand total can never be reset	Set non-resettable grand total password
Display	Display Flow Rate and Total at the same time	Set upper display for Grand Total and lower display to toggle between rate and total.
Sampling	Take a 1 pint sample every 100,000 gallons	Set up relay for sampling and to trip every 0.1 million gallons. Set up sampling time such that 1 pint is sampled.

MOUNTING OPTIONS

Pipe Mounting Kit

The meter can also be mounted to a pipe using the optional pipe mounting kit (PDA6260). This kit includes two mounting plates, two U-bolts, and the necessary nuts and bolts. See *PD2-6200/PD2-6300 manual for instructions*.

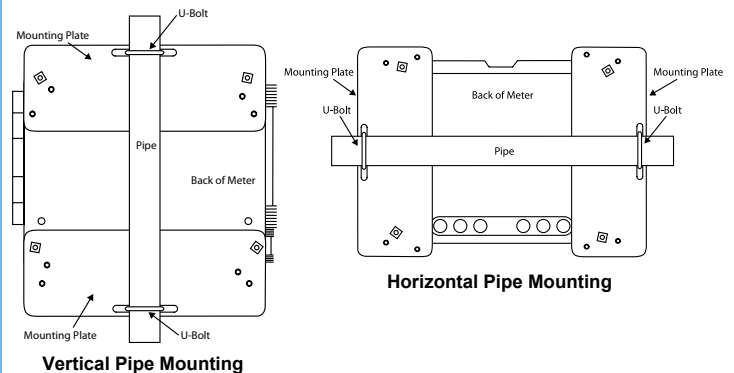

Wall Mounting

The Helios meter can be mounted to any wall using the four provided mounting holes. Note that the bottom mounting holes are located behind the front door panel. See *PD2-6200/PD2-6300 manual for instructions*.

PD2-6200/PD2-6300 Helios Flow Rate/Totalizers

CONNECTIONS

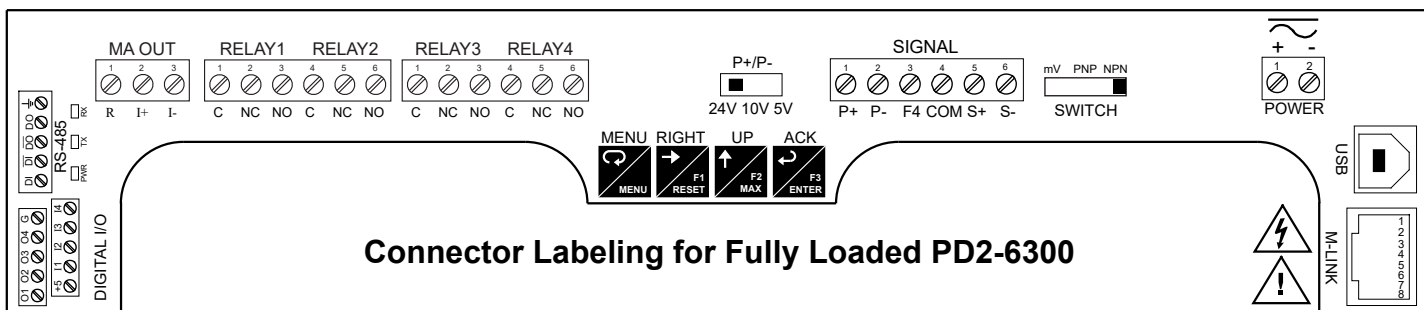
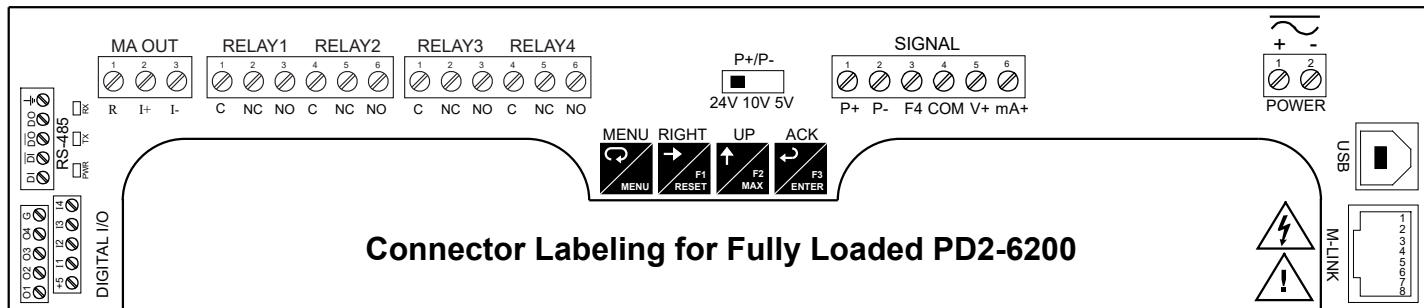

SPECIFICATIONS

Except where noted all specifications apply to operation at +25°C.

General

Display: Two lines with 1.8" (46 mm) high digits, red LEDs; 6 digits per line (-99999 to 999999), with lead zero blanking

Display Intensity: Eight user selectable intensity levels

Display Update Rate: 5/second (200 ms)

Overrange: Display flashes 999999

Underrange: Display flashes -99999

Display Assignment: Display lines 1 & 2 may be assigned to rate, total, grand total, alternate (rate/total, rate/grand total, rate/units, total/units, and grand total/units), set points, max/min, units (line 2 only), and Modbus input. Additional displays are available if parameter total is off, and parameter d-SCAL is on: gross, alternating gross/net, PV1, PV2, and PCT (refer to PD2-6200/PD2-6300 instruction manual on www.predig.com).

Programming Methods: Four programming buttons, digital inputs, PC and MeterView Pro software, or Modbus registers.

F4 Digital Input Contacts: 3.3 VDC on contact. Connect normally open contacts across F4 to COM.

F4 Digital Input Logic Levels: *Logic High:* 3 to 5 VDC
Logic Low: 0 to 1.25 VDC

Noise Filter: Programmable from 2 to 199 (0 will disable filter)

Filter Bypass: Programmable from 0.1 to 99.9% of calibrated span

Recalibration: All ranges are calibrated at the factory. Recalibration is recommended at least every 12 months.

Max/Min Display: Max/min readings reached by the process are stored until reset by the user or until power to the meter is turned off.

Password: Three programmable passwords restrict modification of programmed settings.

Pass 1: Allows use of function keys and digital inputs

Pass 2: Allows use of function keys, digital inputs and editing set/reset points

Pass 3: Restricts all programming, function keys, and digital inputs

Total: Prevents resetting the total manually

Gtotal: Prevents resetting the grand total manually.

Non-Volatile Memory: All programmed settings are stored in non-volatile memory for a minimum of ten years if power is lost.

Power Options: 85-265 VAC 50/60 Hz, 90-265 VDC, 20 W max or 12-24 VDC ± 10%, 15 W max. Powered over USB for configuration only.

Fuse: Required external fuse: UL Recognized, 5 A max, slow blow; up to 6 meters may share one 5 A fuse

Isolated Transmitter Power Supply: Terminals P+ & P-: 24 VDC ± 10%. 12-24 VDC powered models selectable for 24, 10, or 5 VDC supply (internal P+/P- switch). 85-265 VAC models rated @ 200 mA max, 12-24 VDC powered models rated @ 100 mA max, @ 50 mA max for 5 or 10 VDC supply.

Normal Rejection Mode: Greater than 60 dB at 50/60 Hz

Isolation: 4 kV input/output-to-power line; 500 V input-to-output or output-to-P+ supply

Overvoltage Category: Installation Overvoltage Category II: Local level with smaller transient overvoltages than Installation Overvoltage Category III.

Environmental: *Operating temperature range:* -40 to 150°F (-40 to 65°C)

Storage temperature range: -40 to 185°F (-40 to 85°C)

Relative humidity: 0 to 90% non-condensing

Connections: Removable and integrated screw terminal blocks accept 12 to 22 AWG wire.

Enclosure: UL Type 4X, IP65 rated. Polycarbonate & glass blended plastic case, color: gray. Includes four PG11 through-hole conduit openings, with two factory installed PG11, IP68, black nylon threaded hole plugs with backing nuts.

Wall Mounting: Four (4) mounting holes provided for screwing meter into wall. See *PD2-6200/PD2-6300 manual for instructions*.

Pipe Mounting: Optional pipe mounting kit (PDA6260) allows for pipe mounting. Sold separately. See *PD2-6200/PD2-6300 manual for instructions*.

Tightening Torque: *Removable Screw Terminals:* 5 lb-in (0.56 Nm)

Digital I/O and RS485 Terminals: 2.2 lb-in (0.25 Nm)

Overall Dimensions: 10.63" x 12.59" x 4.77"
(270 mm x 319.7 mm x 121.2 mm) (W x H x D)

Weight: 6.10 lbs (2.76 kg)

UL File Number: UL & C-UL Listed. E160849; 508 Industrial Control Equipment.

Warranty: 3 years parts & labor

USB Connection: Compatibility: USB 2.0 Standard, Compliant
Connector Type: Micro-B receptacle

Cable: USB A Male to Micro-B Cable

Driver: Windows 98/SE, ME, 2000, Server 2003/2008, XP 32/64-Bit, Vista 32/64-Bit, Windows 7 32/64-Bit, Windows 10 32/64-Bit

Power: USB Port

PD2-6200/PD2-6300 Helios Flow Rate/Totalizers

Analog Inputs (PD2-6200)

Inputs: Field selectable: 0-20, 4-20 mA, ± 10 V (0-5, 1-5, 0-10 V), Modbus PV (Slave)

Accuracy: $\pm 0.03\%$ of calibrated span ± 1 count, square root & programmable exponent accuracy range: 10-100% of calibrated span

Temperature Drift: 0.005% of calibrated span/ $^{\circ}$ C max from 0 to 65 $^{\circ}$ C ambient, 0.01% of calibrated span/ $^{\circ}$ C max from -40 to 0 $^{\circ}$ C ambient

Signal Input Conditioning: Linear, square root, programmable exponent, or round horizontal tank volume calculation.

Multi-Point Linearization: 2 to 32 points

Programmable Exponent: 1.0001 to 2.9999

Round H Tank: Diameter & Length: 999.999 inch or cm calculates volume in gallons or liters respectively.

Low-Flow Cutoff: 0-999999 (0 disables cutoff function)

Decimal Point: Up to five decimal places or none: dddddd, dddddd, dddddd, dddddd, dddddd, or dddddd.

Calibration Range:

Input Range	Minimum Span Input 1 & Input 2
4-20 mA	0.15 mA
± 10 V	0.10 V

An Error message will appear if the input 1 and input 2 signals are too close together.

Input Impedance: Voltage ranges: greater than 1 M Ω .

Current ranges: 50 - 100 Ω (depending on resettable fuse impedance).

Input Overload: Current input protected by resettable fuse, 30 VDC max. Fuse resets automatically after fault is removed.

F4 Digital Input Contacts: 3.3 VDC on contact. Connect normally open contacts across F4 to COM.

F4 Digital Input Logic Levels: Logic High: 3 to 5 VDC

Logic Low: 0 to 1.25 VDC

Pulse Inputs (PD2-6300)

Inputs: Field selectable: Pulse or square wave 0-5 V, 0-12 V, or 0 24 V @ 30 kHz; TTL; open collector 4.7 k Ω pull-up to 5 V @ 30 kHz; NPN or PNP transistor, switch contact 4.7 k Ω pull-up to 5 V @ 40 Hz; Modbus PV (Slave)

Low Voltage Mag Pickup (Isolated): Sensitivity: 40 mVp-p to 8 Vp-p

Minimum Input Frequency: 0.001 Hz - Minimum frequency is dependent on high gate setting.

Maximum Input Frequency: 30,000 Hz (10,000 for Low Voltage Mag Pickup)

Input Impedance: Pulse input: Greater than 300 k Ω @ 1 kHz.

Open collector/switch input: 4.7 k Ω pull-up to 5 V.

Accuracy: $\pm 0.03\%$ of calibrated span ± 1 count

Display Update Rate: Total: 10/sec, Rate: 10/sec to 1/1000 sec

Temperature Drift: Rate display is not affected by changes in temperature.

Multi-Point Linearization: 2 to 32 points

Low-Flow Cutoff: 0-999999 (0 disables cutoff function)

Decimal Point: Up to five decimal places or none: dddddd, dddddd, dddddd, dddddd, dddddd, or dddddd.

Calibration: May be calibrated using K-factor, internal calibration, or by applying an external calibration signal.

K-Factor: Field programmable K-factor converts input pulses to rate in engineering units. May be programmed from 0.00001 to 999,999 pulses/unit.

Calibration Range: Input 1 signal may be set anywhere in the range of the meter; input 2 signal may be set anywhere above or below input 1 setting. Minimum input span between any two inputs is 10 Hz.

An error message will appear if the input 1 and input 2 signals are too close together.

Filter: Programmable contact de-bounce filter, 40 to 999 Hz maximum input frequency allowed with low speed filter.

Time Base: Second, minute, hour, or day

Low Gate: 0.1-99.9 seconds

High Gate: 2.0-999.9 seconds

Rate/Totalizer

Rate Display Indication: -99999 to 999999, lead zero blanking. "R" LED illuminates while displaying rate.

Total Display & Total Overflow: 0 to 999,999; automatic lead zero blanking. "T" LED is illuminated while displaying total or grand total.

Up to 999,999,999 with total-overflow feature. "oF" is displayed to the left of total overflow and \blacktriangle LED is illuminated.

Alternating Display: Either display may be programmed to alternate between rate and total or rate and grand total every 10 seconds.

Total Decimal Point: Up to five decimal places or none: dddddd, dddddd, dddddd, dddddd, dddddd, or dddddd.

Total decimal point is independent of rate decimal point.

Totalizer: Calculates total based on rate and field programmable multiplier to display total in engineering units. Time base must be selected according to the time units in which the rate is displayed.

Totalizer Rollover: Totalizer rolls over when display exceeds 999,999,999. Relay status reflects the display value.

Total Overflow Override: Program total reset for automatic with 0.1 second delay and set point 1 for 999,999

Totalizer Presets: Up to eight, user selectable under setup menu. Any set point can be assigned to total and may be programmed anywhere in the range of the meter for total alarm indication.

Programmable Delay On Release: 0.1 to 999.9 seconds; applied to the first relay assigned to total or grand total. If the meter is programmed to reset total to zero automatically when the preset is reached, then a delay will occur before the total is reset.

Total Reset: Via button behind front panel door, external contact closure on digital inputs, automatically via user selectable preset value and time delay, or through serial communications.

Total Reset Password: Total and grand total passwords may be entered to prevent resetting the total or grand total.

Non-Resettable Total: The grand total can be programmed as a non-resettable total by entering the password "050873".

CAUTION: Once the Grand Total has been programmed as "non-resettable" the feature CANNOT be disabled.

Relays

Rating: 2 or 4 SPDT (Form C) internal and/or 4 SPST (Form A) external; rated 3 A @ 30 VDC and 125/250 VAC resistive load; 1/14 HP (\approx 50 W) @ 125/250 VAC for inductive loads

Noise Suppression: Noise suppression is recommended for each relay contact switching inductive loads.

Relay Assignment: Relays may be assigned to rate, total, or grand total.

Deadband: 0-100% of span, user programmable

High or Low Alarm: User may program any alarm for high or low trip point. Unused alarm LEDs and relays may be disabled (turned off).

Relay Operation: Automatic (non-latching) and/or manual reset

Latching (requires manual acknowledgment) with/without clear

Pump alternation control (2 to 4 relays)

Sampling (based on time)

Off (disable unused relays and enable Interlock feature)

Manual on/off control mode

Relay Reset: User selectable buttons behind front panel, digital inputs

1. Automatic reset only (non-latching), when input passes the reset point or total is reset to zero.
2. Automatic + manual reset at any time (non-latching).
3. Manual reset only, at any time (latching).
4. Manual reset only after alarm condition has cleared (latching).

Note: Button behind front panel or digital input may be assigned to acknowledge relays programmed for manual reset.

Deadband: 0-100% of span, user programmable

Time Delay: 0 to 999.9 seconds, on & off relay time delays. Programmable and independent for each relay.

Fail-Safe Operation: Programmable and independent for each relay.

Note: Relay coil is energized in non-alarm condition. In case of power failure, relay will go to alarm state.

Auto Initialization: When power is applied to the meter, relays will reflect the state of the input to the meter.

Isolated 4-20 mA Transmitter Output

Output Source: Process variable (PV), max, min, set points 1-4, Modbus input, or manual control mode

Scaling Range: 1.000 to 23,000 mA for any display range

Calibration: Factory calibrated: 4.000 to 20.000 = 4-20 mA output

PD2-6200/PD2-6300 Helios Flow Rate/Totalizers

Analog Out Programming: 23.000 mA maximum for all parameters:

Overrange, underrange, max, min, and break

Accuracy: $\pm 0.1\%$ of span ± 0.004 mA

Temperature Drift: 0.4 $\mu\text{A}/^\circ\text{C}$ max from 0 to 65 $^\circ\text{C}$ ambient,

0.8 $\mu\text{A}/^\circ\text{C}$ max from -40 to 0 $^\circ\text{C}$ ambient

Note: Analog output drift is separate from input drift.

Isolated Transmitter Power Supply: Terminals I+ & R: 24 VDC $\pm 10\%$.

Isolated from the input at >500 V. May be used to power the 4-20 mA output or other devices. All models rated @ 40 mA max.

External Loop Power Supply: 35 VDC maximum

Output Loop Resistance:

Power Supply	Minimum	Maximum
24 VDC	10 Ω	700 Ω
35 VDC (external)	100 Ω	1200 Ω

RS-485 Serial Communications Terminal

Compatibility: EIA-485

Connectors: Removable screw terminal connector

Max Distance: 3,937' (1,200 m) max

Status Indication: Separate LEDs for Power (P), Transmit (TX), and Receive (RX)

Modbus® RTU Serial Communications

Slave ID: 1 - 247

Baud Rate: 300 - 19,200 bps

Transmit Time Delay: Programmable between 0 and 199 ms or transmitter always on for RS-422 communication

Data: 8 bit (1 start bit, 1 or 2 stop bits)

Parity: Even, odd, or none with 1 or 2 stop bits

Byte-to-Byte Timeout: 0.01 - 2.54 seconds

Turn Around Delay: Less than 2 ms (fixed)

Note: Refer to the Modbus Register Tables located at www.predig.com for details.

Digital Input & Output Terminal

Channels: 4 digital inputs & 4 digital outputs

Digital Input Logic High: 3 to 5 VDC

Digital Input Logic Low: 0 to 1.25 VDC

Digital Output Logic High: 3.1 to 3.3 VDC

Digital Output Logic Low: 0 to 0.4 VDC

Source Current: 10 mA maximum output current

Sink Current: 1.5 mA minimum input current

+5 V Terminal: To be used as pull-up for digital inputs only. Connect normally open pushbuttons across +5 V & DI 1-4.

WARNING! DO NOT use +5 V terminal to power external devices.

Your Local Distributor is:

Disclaimer

The information contained in this document is subject to change without notice. Precision Digital Corporation makes no representations or warranties with respect to the contents hereof, and specifically disclaims any implied warranties of merchantability or fitness for a particular purpose. ©2016-2018 Precision Digital Corporation. All rights reserved.

DIMENSIONS

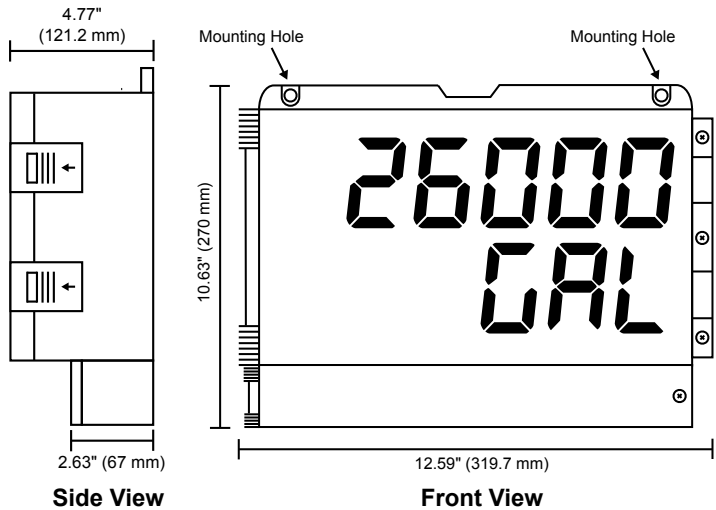

ORDERING INFORMATION

Helios PD2-6200 Flow/Rate Totalizer Models		
85-265 VAC Model	12-24 VDC Model	Options Installed
PD2-6200-6H0	PD2-6200-7H0	No Options
PD2-6200-6H7	PD2-6200-7H7	4 Relays & 4-20 mA Output

Note: 24 V Transmitter power supply standard on all models.

Helios PD2-6300 Flow/Rate Totalizer Models		
85-265 VAC Model	12-24 VDC Model	Options Installed
PD2-6300-6H0	PD2-6300-7H0	No Options
PD2-6300-6H7	PD2-6300-7H7	4 Relays & 4-20 mA Output

Note: 24 V Transmitter power supply standard on all models.

Accessories	
Model	Description
PDA6260	Pipe Mounting Kit
PDA7485-I	RS-232 to RS-422/485 Isolated Converter
PDA7485-N	RS-232 to RS-422/485 Non-Isolated Converter
PDA8485-I	USB to RS-422/485 Isolated Converter
PDA8485-N	USB to RS-422/485 Non-Isolated Converter
PDAPLUG2	Plastic Conduit Plug
PDX6901	Suppressor (snubber): 0.01 $\mu\text{F}/470 \Omega$, 250 VAC

LDS2-6200_C 08/18