

AUTOMATION

PRODUCTS
GROUP, INC.

Operator's Manual

MND

Modbus Network Display

DOC. 9003708

Rev. A, 6/15



Automation Products Group, Inc.

Table of Contents

Warranty.....	3
Display Wiring	4-6
Using the MND	7
Access Modes.....	8
Menu Flow Chart.....	9
Units of Measure.....	10
Enter Button Function	10
Advanced Settings	11-12
Auto-Off	11
Decimal Place.....	11
Digit Mask.....	11
Digit Shift	11
Multiplier	11
Bar Graph.....	11
Overload	12
Battery Indicator	12
Outputs	13-17
Analog Settings	13
Solid State Relay Settings	13-16
Switchable Power Source.....	17
Communications Settings	18-20
Sensor Labels.....	21
Percent Full Mode	21
Back Light	21
Using the APG Modbus Software	22-25
Communications Setup Examples	26
Resetting to Factory Defaults	27
Specifications.....	28
Sensor Register Lists.....	29-30

- **Warranty and Warranty Restrictions**

APG warrants its products to be free from defects of material and workmanship and will, without charge, replace or repair any equipment found defective upon inspection at its factory, provided the equipment has been returned, transportation prepaid, within 24 months from date of shipment from factory.

THE FOREGOING WARRANTY IS IN LIEU OF AND EXCLUDES ALL OTHER WARRANTIES NOT EXPRESSLY SET FORTH HEREIN, WHETHER EXPRESSED OR IMPLIED BY OPERATION OF LAW OR OTHERWISE INCLUDING BUT NOT LIMITED TO ANY IMPLIED WARRANTIES OF MERCHANTABILITY OR FITNESS FOR A PARTICULAR PURPOSE.

No representation or warranty, express or implied, made by any sales representative, distributor, or other agent or representative of APG which is not specifically set forth herein shall be binding upon APG. APG shall not be liable for any incidental or consequential damages, losses or expenses directly or indirectly arising from the sale, handling, improper application or use of the goods or from any other cause relating thereto and APG's liability hereunder, in any case, is expressly limited to the repair or replacement (at APG's option) of goods.

Warranty is specifically at the factory. Any on site service will be provided at the sole expense of the Purchaser at standard field service rates.

All associated equipment must be protected by properly rated electronic/ electrical protection devices. APG shall not be liable for any damage due to improper engineering or installation by the Purchaser or third parties. Proper installation, operation and maintenance of the product becomes the responsibility of the user upon receipt of the product.

Returns and allowances must be authorized by APG in advance. APG will assign a Return Material Authorization (RMA) number which must appear on all related papers and the outside of the shipping carton. All returns are subject to the final review by APG. Returns are subject to restocking charges as determined by APG's "Credit Return Policy".

Display Wiring

4/C Cable (22 AWG 2-TP)	No Output	4-20 mA	Switchable Power
+24 VDC	Red*	Red	
DC Ground	Black*		Black
RS-485 A+	White	White	White
RS-485 B-	Green	Green	Green
4-20 mA		Black	
Relay Power			Red

*No connection for MND's with internal batteries

4-pin MM12	No Output	4-20 mA	Switchable Power
1 Brown	+24 VDC*	+24 VDC	Relay Power
2 White	RS-485 A+	RS-485 A+	RS-485 A+
3 Blue	DC Ground*	4-20 mA Out	DC Ground
4 Black	RS-485 B-	RS-485 B-	RS-485 B-

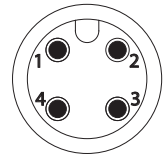

*No connection for MND's with internal batteries

5/C Cable (22 AWG)	No Output	4-20 mA	Switchable Power	0-3 VDC
+24 VDC	Red*	Red		Red
DC Ground	Black*		Black	Black
RS-485 A+	White	White	White	White
RS-485 B-	Green	Green	Green	Green
4-20 mA		Black		
Relay Power			Red	
0-3 VDC				Orange

*No connection for MND's with internal batteries

5-pin MM12	No Output	4-20 mA	Switchable Power	0-3 VDC
1 Brown	+24 VDC*	+24 VDC	Relay Power	+24 VDC
2 White	RS-485 A+	RS-485 A+	RS-485 A+	RS-485 A+
3 Blue	DC Ground*	4-20 mA Out	DC Ground	DC Ground
4 Black	RS-485 B-	RS-485 B-	RS-485 B-	RS-485 B-
5 Grey	N/C	N/C	N/C	Analog Out

*No connection for MND's with internal batteries

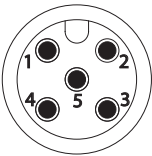

6-pin Tajimi	No Output	4-20 mA	Switchable Power	0-3 VDC
A	+24 VDC*	+24 VDC	Relay Power	+24 VDC
B	DC Ground*	4-20 mA Out	DC Ground	DC Ground
C	RS-485 A+	RS-485 A+	RS-485 A+	RS-485 A+
D	RS-485 B-	RS-485 B-	RS-485 B-	RS-485 B-
E	N/C	N/C	N/C	Analog Out
F	N/C	N/C	N/C	N/C

*No connection for MND's with internal batteries

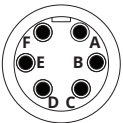

8/C Cable (22 AWG)	2 NO/NC Relays	0-3 VDC & 2 Relays
+24 VDC	Red	Red
DC Ground	Black	Black
RS-485 A+	White	White
RS-485 B-	Green	Green
0-3 VDC		Orange
NO/NC1	Yellow	Yellow
Com1	Blue	Blue (Shared)
Com2	Brown	
NO/NC2	Orange	Brown

8-pin MM12	2 NO/NC Relays	0-3 VDC & 2 NO/ NC Relays
1 White	RS-485 A+	RS-485 A+
2 Brown	+24 VDC	+24 VDC
3 Green	RS-485 B-	RS-485 B-
4 Yellow	NO/NC 1	NO/NC 1
5 Grey	Com 1	Com 1/2
6 Pink	Com 2	NO/NC 2
7 Blue	DC Ground	DC Ground
8 Red	NO/NC 2	Analog Out

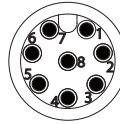

Using the MND



Increase Button

Function in Operating Mode: cycles through sensor readings when setup to display multiple sensors readings.

Function within Setup Menu: press to cycle upward through menu options or to increase mode setting values.

Decrease/Power Button

Function in Operating Mode: press and hold for 1 second to power on or off the MND.

Function within Setup Menu: press to cycle downward through menu options or decrease mode setting values.

Enter Button

Function in Operating Mode: cycles between the current, maximum, and minimum readings.

Function within Setup Menu: press to enter into the selected menu or to accept a setting option within a menu.

*Access Modes

The MND has several operating modes which will limit or lock access to the setup menus. Refer to the mode descriptions at the bottom of the page for more information. To access the operating mode setting, follow the steps below.

Step 1: Simultaneously press and hold the Decrease button and the Enter button for approximately 5 seconds to bring up the *3 digit mode access number.

Step 2: Use the Increase/Decrease buttons to change the value of the flashing digit, and Enter button to accept the value and advance to the next digit. The mode options are as follows:

<u>Mode</u>	<u>Description</u>
000	Full Access. All menu options are accessible, including those that may not be applicable to all MND configurations.
001	Locks access to all setup menus. The Increase Button will scroll through sensor readings when the MND is configured for multiple sensors. The Decrease/Power Button will turn on/off the display. The Enter button will scroll between the maximum, minimum and the current reading.
002	Hides the Output menu. All other setup menus are accessible.
003	Hides the analog options in the Output menu--only the relay options are accessible.
004	Hides the relay options in the Output menu--only the analog options are accessible.
005	All menus are hidden and all buttons are lock, except the Decrease/Power button, which will power on/off the MND.

*Also see **“Setting Mode Access Password”** under Sensor Label section of page 21.

Menu Flow Chart

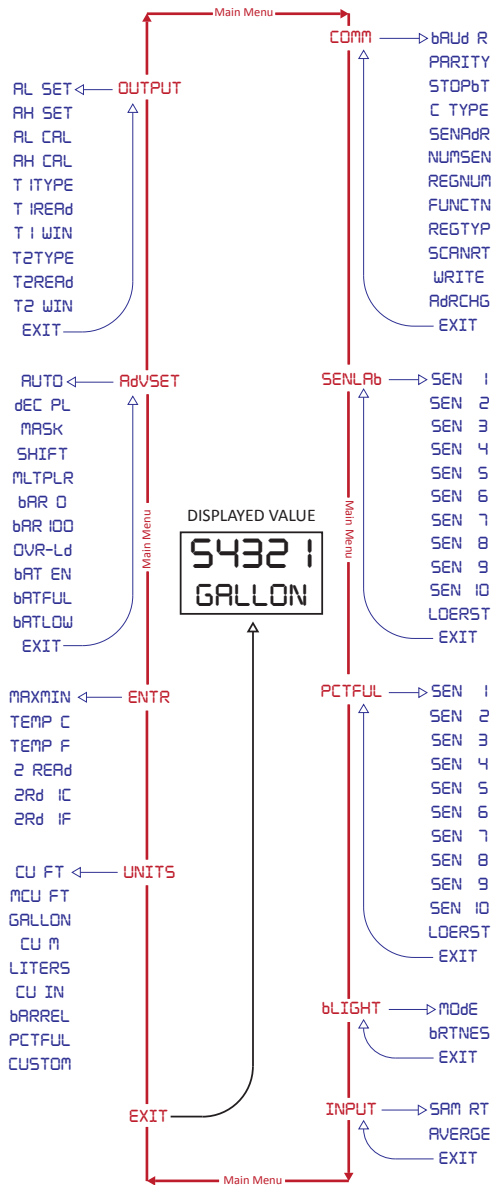

• UNITS (Units of Measure Label)

Allows the user to select the unit of measure label that will appear on the lower display line.

Options:

CU FT (Cubic Feet)	LITERS (Liters)
MCU FT (Million Cubic Feet)	CU IN (Cubic Inches)
GALLON (Gallons)	BARREL (Barrels)
CU M (Cubic Meters)	PCTFUL (Percent Full)
CUSTOM (Custom Units)	

NOTE: the units of measure selected will be applied to all sensor readings and cannot be set individually for each sensors.

NOTE: the units label will automatically display PCTFUL (percent full) for any reading being displayed in Percent Full mode (see page 20 for more information).

• ENTR (Enter Button Function)

Selects the function of the ENTER button when in standard operating mode.

Enter Button Function:

MAXMIN	cycles between the present reading and the highest and lowest readings.
TEMP C	cycles between the reading and the temperature in °C.
TEMP F	cycles between the reading and the temperature in °F.
2 READ*	cycles between 2 readings.
2RD 1C*	cycles between 2 readings & temperature in °C.
2RD 1F*	cycles between 2 readings & temperature in °F.

***2nd reading is applicable to MPX dual-float sensors only.**

• ADVSET (Advanced Settings)

AUTO (Auto Off): The Auto-Off feature will automatically power off the MND whenever no buttons are pressed within the specified time frame. The minimum Auto-Off time is 15 seconds. To disable the Auto-Off feature, set the value to 65535 (default).

NOTE: the Auto-Off cannot be set to less than the relay “On Time” setting when using the Timed Relay option (see Outputs).

DEC_PL (Decimal Place): defines where the decimal point will be displayed within the reading.

NOTE: most APG sensors have the ability to set the number of decimal places of the readings being sent to the MND. Refer to the sensor manual for more information.

MASK (Digit Mask): allows the user to mask the value of the least significant digit(s), up to 3 places, so that masked digit(s) will always display 0 and will not increment.

SHIFT (Digit Shift): allows the user to shift the reading to the right by dividing the reading by 10, 100, or 1000.

MULTIPLE (Multiplier): allows the user to apply a conversion multiplier to the sensor readings. For example, a multiplier setting of 2.0 will double the reading received from the sensor.

NOTE: most APG sensors have the capability to apply a conversion multiplier to the reading before the value it is sent to the MND.

BAR_0 (Bar Graph 0%) & **BAR100** (Bar Graph 100%): define the readings associated with 0% and 100% on the display bar graph. Bars will appear/disappear in 10% increments of the total span.

NOTE: the bar graph limits will be applied to all sensor readings when multiple sensor are being displayed, and cannot be set individually for each sensor.

OVRLD (Overload): allows the user to set an overload warning if the reading increases beyond the specified value.

NOTE: when displaying the readings from multiple sensors, the Overload setting will be applied to the readings of all the sensors and cannot be set for each sensor individually. By default the Overload is set to 99999 so that the overload warning will only be displayed when a sensor reading is greater than 5-digit limit of the display.

BAT EN (Battery Enabled): allows the user to select either No Battery, Internal Battery or RST Battery options. The Internal Battery option is used to monitor the voltage of a battery powered MND. The RST Battery option is used to monitor the supply voltage of an RST-5000 module acting as the master device.

NOTE: the Internal battery indicator is limited to battery voltages less than 15 Vdc.

BATFUL (Battery Full Voltage): sets the voltage associated with a full battery indication.

BATLOW (Battery Low Voltage): sets the voltage associated with a low battery indication.

• OUTPUT (Outputs)

The MND is offered with optional outputs, such as solid-state relays, or 4-20 mA or 0-3 Vdc analog signals. Not all output menu options are applicable to all MND configurations.

NOTE: when displaying the readings from multiple sensors, the Sensor Address setting determines which sensor is controlling the output(s) of the MND.

AL SET (Analog Low Set-point): sets the reading associated with the low analog value (either 4mA or 0V).

AH SET (Analog High Set-point): sets the reading associated with the high analog value (either 20mA or 3V).

AL CAL (Analog Low Calibration): adjusts the low end of the analog output (either 4mA or 0V). Increasing/decreasing the value will cause an increase/decrease at the low end of the analog output.

AH CAL (Analog High Calibration): adjusts the high end of the analog output (i.e. either 20mA or 3V). Increasing/decreasing the value will cause an increase/decrease at the high end of the analog output.

T1TYPE & T2TYPE (Trip 1&2 Type): determines the basic functional logic of the relay outputs as described in the Trip Type descriptions on pages 14-16.

NOTE: the MND's Telecom Relays are rated for a maximum switched load of 5 Amps at 240 VAC or 220 VDC.

T1READ & T2READ (Trip 1&2 Reading): defines the display reading that corresponds to a change in the state of the associated relay output, as determined by the Trip Type selected.

T1 WIN & T2 WIN (Trip 1&2 Window): defines the secondary value (beginning from the Trip Reading) for Exclusive, Inclusive, and Hysteresis Near & Far Trip Types (refer to descriptions below). For example: if the Trip Reading is set to 250, and the secondary trip value is desired at a reading of 350, then the Trip Window should be set to 100. ($250 + 100 = 350$)

Trip Type Descriptions

NEAR:

The output will activate whenever the reading is less than the Trip Reading setting.

EXCLSV

(Exclusive):

The output will activate whenever the reading is less than the Trip Reading OR greater than the Trip Reading + Trip Window.

H NEAR

(Hysteresis Near):

The output will activate until the reading is greater than the Trip Reading + Trip Window, at which point the output will deactivate and remain in that state until the reading is less than the Trip Reading.

FAR:

The output will activate whenever the reading is greater than the Trip Reading.

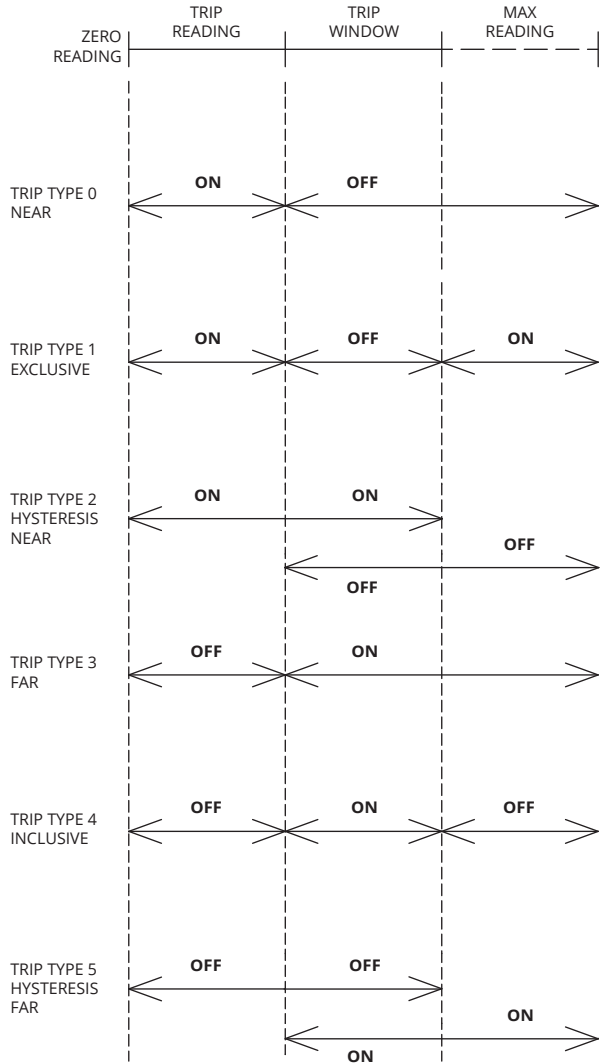

NOTE: for Normally Closed relays, the active state--ON--is Open, and for Normally Open relays, the active state is Closed.

INCL 5V (Inclusive):

The output will activate whenever the reading is greater than the Trip Reading and less than the Trip Reading + Trip Window.

H FAR (Hysteresis Far):

The output will activate when the reading increases beyond the Trip Reading + Trip Window, and will remain active until the reading falls below the Trip Reading. The output will remain deactivated until the reading is once again greater than the Trip Reading + Trip Window.

ON:

Holds the output closed whenever the display is powered.

OFF:

Disables the output.

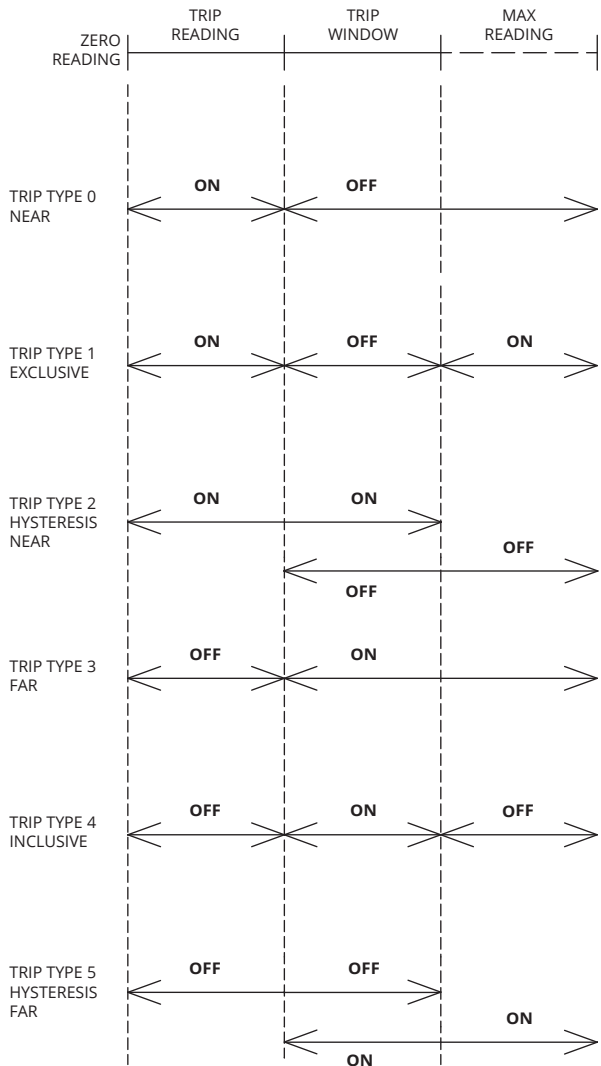

NOTE: for Normally Closed relays, the active state--ON--is Open, and for Normally Open relays, the active state is Closed.

LOERST (LOE/RST):

forces the output to follow the state of the corresponding output of an LOE or RST sensor acting as the master device. For example, whenever output T1 of the LOE/RST activates/deactivates, then output T1 of the MND will activate/deactivate as well.

TIME R*(Timed Interval):

sets the output to activate on a timed interval. The Interval-Time (INTMIN) sets the time between activations (in minutes), and the On-Time (ON SEC) determines how long the output remains active at each interval (in seconds).

NOTE: when using the Timed Interval in conjunction with the Auto-Off feature, the MND will wake (power on) at each Interval and will remain powered on for the duration of the relay On-Time regardless of the Auto-Off setting.

*Also refer to Switchable Power Source Option on next page.

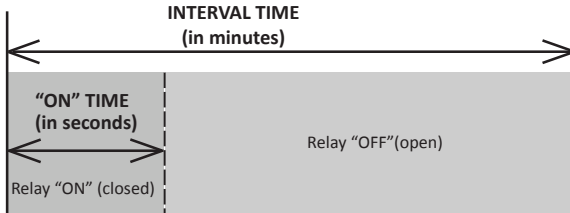
H TEMP* (Heater Temperature):

The LCD heater is controlled using Trip Relay 1. Set the heater “on” temperature using the Trip 1 Reading (T1READ) parameter (in °C). The Trip 1 Window (T1WIN) parameter is used to set the “off” temperature, defined by the number of degrees above the on temperature.

For Example: to activate the heater at -30 °C and deactivate the heater above -10 °C

```
T1TYPE set to H TEMP
T1READ set to -0030
T1WIN set to 00020
```

*Optional Feature

Switchable Power Source Output*

(refer to Switchable Power wiring on pages 4-5)

This option is designed to allow an internal battery powered MND to share its battery power (via relay T1) with one of APG's Modbus sensors (MNU, MPX, or PT series) to create a simple yet complete monitoring system. Pushing the MND's power button will wake the system from sleep mode, poll the sensor reading, and then re-enter sleep mode a few seconds later.

The Switchable Power option utilizes Relay T1, which is set to the Timed Relay mode, to control the voltage to the sensor. Setting the Interval Time to 0 will force the T1 to active and supply power to the sensor immediately when the MND wakes from sleep mode. The On Time setting determines how long power is supplied to the sensor. APG recommends an On Time of 8-10 seconds to allow the sensor enough time to power up and get a reading. The Auto-Off setting determines how long the MND will remain powered, displaying the reading, before re-entering sleep mode.

The following are APG's recommend settings for using this feature:

Output Menu (OUTPUT):

- Trip 1 Type (T1TYPE) = Timed Relay (TIME R)
- Interval in minutes (INTMIN) = 0
- On Time in seconds (ON SEC) = 8-10

Advanced Menu (AdvSET):

- Auto-Off = 15 seconds

WARNING!

The Switchable Power option sources battery voltage directly to the output line whenever the display is powered "on". Care must be taken not to short this voltage to any of the other output lines (DC common or the A and B communication lines).

*The Switchable Power Source Output option requires a special hardware configuration from the factory and is not a standard MND feature.

- **COMM (Communications)**

BAUD R (Baud Rate): 2400, 9600, 19200, 38400

PARITY: even, odd, none

STOPBIT (Stop Bit): 1, 2

NOTE: all APG Modbus based sensors communicate using 9600 baud, no parity and 1 stop bit.

C TYPE (Communications Type):

MASTER: sets the MND to operate as the master device.

SNIFER (Sniffer): sets the MND to passively monitor communications between a master device and one or more sensors. The master device must be actively polling the sensor(s) in order for the MND to update the reading(s).

LRSNIF (LOE/RST Sniffer): functions the same as Sniffer mode with addition of monitoring the readings from an LOE series or RST-5000 series Ethernet based sensor (acting as the master device).

SETUP: sets the MND to act operate as a “slave” device in order to be programmed using the APG Modbus software.

NOTE: the Sensor Address parameter (see below) is used to set the MND’s own sensor address when operating in Setup mode.

SENADR (Sensor Address): sets the address number of the sensor to be displayed when only one sensor is being monitored. The Sensor Address is also used to set the MND’s own address when operating in Setup mode.

NOTE: in order to monitor readings from multiple sensors, the assigned sensor address numbers must begin at 1 and increment sequentially. For example, if 5 sensors are to be monitored, the sensor addresses must be set to 1 thru 5.

NOTE: when displaying the readings from multiple sensors, the Sensor Address setting determines which sensor is controlling the output(s) of the MND.

NUMSEN (Number of Sensors): sets the number of sensors to be monitored. When using the MND to display readings from multiple sensors, the sensor addresses must begin at 1 and increment sequentially (see note above).

REGNUM (Register Number): sets the register number to be displayed. The readings of APG sensors are stored in register 30303.

NOTE: the register number is entered using only the last 3 digits of the full register number. For example, register 30303 would be entered as 303, or register 40401 would be entered as 401.

FUNCTION (Function): sets the function code for the register to be displayed; 3 = holding register, 4 = input register. Sensor readings are stored in input registers, while sensor parameter values are stored in holding registers.

REGTYPE (Register Type): sets the bit type of the register to be displayed. Options are:

signed, 8 bit, low byte (S8L)	signed, 16 bit (S16)
signed, 8 bit, high byte (S8H)	unsigned, 16 bit (U16)
unsigned, 8 bit, low byte (U8L)	signed, 32 bit (S32)
unsigned, 8 bit, high byte (U8H)	unsigned, 32 bit (U32)

NOTE: the readings of APG's sensors are stored as an unsigned 32-bit value. Refer to the sensor's user manual for a list of register numbers and their corresponding register types.

SCANRT (Scan Rate): determines how often the MND polls the sensor(s) (in seconds) when operating in Master mode.

WRITE: allows the MND, operating in Master mode, to write a value to a specific holding register of a specific sensor. When Write is selected, the MND will guide you through the following steps:

- Sensor Address**: set the address number of the target sensor.
- Register Number**: set the register number you wish to change.
- Register Type**: set the type of register being written (16-bit or 32-bit).
- Register Value**: set the value you want to write to the selected register.
- Write Yes/No**: select Yes to write the new register value and complete the procedure, or No to cancel the write, and return to the Communications menu.

Write function example: changing the Empty Distance value (register 40407) to 2150 in sensor address number 5.

- Sensor Address**: 05
- Register Number**: 407
- Register Type**: U16 (unsigned 16-bit).
- Register Value**: 02150
- Write Yes/No**: select Yes by pressing Enter.

ADDRCHG (Address Change): allows the user to quickly change a sensor's address when the MND is operating as the Master device. Simply enter the current address of sensor you wish to change (**OLD**), then enter the new address you wish to write to the sensor (**NEW**).

- **SENLAB** (Sensor Labels)

Allows the user to assign a custom label for each sensor being displayed (up to 10 sensors + an LOE/RST master). The sensor label will appear on the lower display line, which will alternate between the Sensor Label and the selected Unit of measure.

NOTE: Setting a Mode Access Password (refer to Access Modes on page 8).

If a label is assigned for Sensor 10, the label becomes the password to access the Mode setting. If the label for sensor 10 is set to the default of 10AAAA, then no password will be required to access the Mode setting.

- **PCTFUL** (Percent Full)

Allows sensor readings to be displayed as a percentage of full based on a user defined 100% value.

To enable the Percent Full feature, select **PCTFUL** in the main menu. Select the sensor number you want to display as a percentage of full, and enter the value associated with 100%. 0% (empty) is assumed to be 0. Setting the value to 00000 (default) will disable the Percent Full feature.

NOTE: the label **PCTFUL** will automatically be displayed as the units of measure for all sensors running in Percent Full mode.

NOTE: when controlling one of the MND's outputs with a sensor setup to display in Percent Full mode, the settings controlling the output need to be entered based on the underlying readings and not the displayed percentage value.

- ***bLIGHT** (Back Light) *Optional Feature

The Mode options include: On, Off, 30 Sec, 1 min, 2 min, 4 min, 8min and 16 min. To adjust the backlight intensity, select brightness (**bRTNES**) in the menu and use the up/down arrow buttons to increase/decrease the brightness.

Programming the MND using APG Modbus Software

The MND's "Setup" communications type (see C-TYPE on page 18) allows the MND to be programmed using software instead of the buttons on the display. The software used to program the MND is the same software used to program any of APG's line of Modbus sensors (MNU, MPX, PT series). Interfacing with the software also allows the user to save MND configurations to a PC, or to write a previously saved configuration back to the MND (see page 25).

Use the following steps to establish communications and program the MND via the APG Modbus software:

Step 1: Use the buttons on the MND to enter the Communications menu and change the Communications Type (C-TYPE) to "SETUP".

Step 2: While still in the MND Communications menu, take note of the Sensor Address (SENADR) setting. This setting will become the MND's address when communicating to the software.

Step 3: Install and run the APG Modbus software.

Step 4: Click on "Configure" in the top menu, then select "Communication" to bring up the Communication Configuration window.

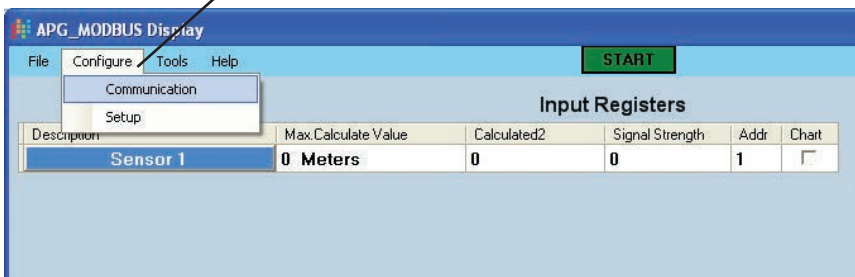

Step 5: Check the USB Communication box when using an RST-6001 RS-485 to USB converter.

or

Select the Com Port assigned to the RS-485 to RS-232 converter being used.

Step 6: Ensure Sensor # matches the Sensor Address setting in the MND.

Step 7: Select MND

Communication Configuration

USB Setup
 USB Communication

Serial Setup
 Comm Port: COM1
 Baud Rate: 9600
 Parity: NONE
 Stop Bit: 1
 Update Comm Port

Timing Delays
 Main Delay: 600
 Delay Between TX_RX: 200

Options
 Auto Start After change
 Load Params. at startup
 Show decimal
 Tool Tip
 Scale to screen
 Zero on bad Readings

Sensor Setup
 Sensor Type: MND
 # of Sensors: 1

Sensor #'s	Description
1	Sensor 1

Save Config CLOSE

Step 8: Once all the changes have been made, click "Save Config" then click "Close"

APG_MODBUS Display

File Configure Tools Help START

Input Registers Chart All

Description	Max Calculate Value	CalculatedQ	Signal Strength	Addr	Chart
Sensor 1	0	0	0	1	<input type="checkbox"/>

Step 9: Click on "Sensor 1" to enter the programming window for the MND.

Step 10: When the programming window opens, the register values should automatically populate (if not, click the “Receive All” button at the bottom of the window). To change a single parameter, simply click on the value you wish to change, enter the desired value, then click the adjacent “Send” button to write the new value to the MND.

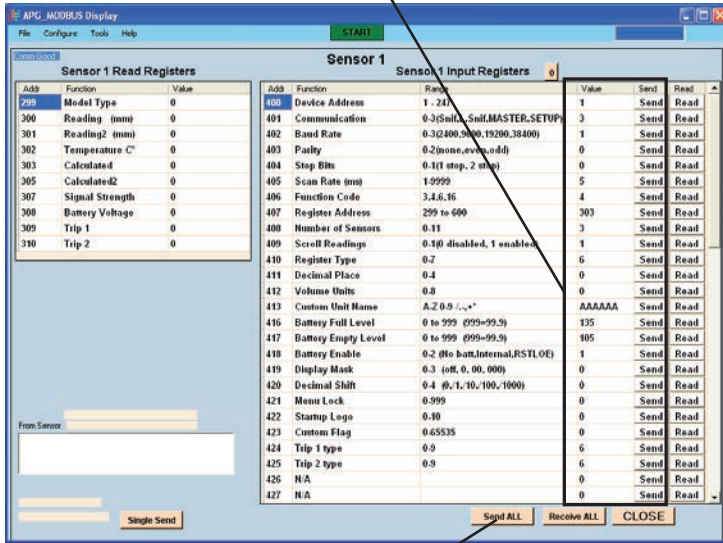

Step 11: To change multiple parameters, individually click on the values you wish to change, enter the desired values, then click the “Send All” button at the bottom of the window to write all the values to the MND.

After clicking “Send” or “Send All”, a green window indicates good communication and the value was successfully written to the MND.

A yellow window indicates the value was not written due to either a communication failure or the value exceeds the allowable limits for that parameter.

405	Scan Rate (ms)	1.9999	5	Send	Read
406	Function Code	3,4,6,16	4	Send	Read
407	Register Address	299 to 600	303	Send	Read
408	Number of Sensors	0-11	3	Send	Read
409	Scroll Readings	0-10 disabled, 1 enabled	1	Send	Read

405	Scan Rate (ms)	1.9999	5	Send	Read
406	Function Code	3,4,6,16	4	Send	Read
407	Register Address	299 to 600	303	Send	Read
408	Number of Sensors	0-11	3	Send	Read
409	Scroll Readings	0-10 disabled, 1 enabled	1	Send	Read

Saving a Settings Configuration

To save the current settings configuration, click on “File”, then select “Save Mode Values”. Choose the file name and location where you wish to save the file, then click “Save”

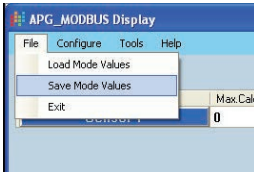

Recalling a Saved Settings Configuration

To upload a previously saved settings configuration to the MND, click on “File”, then select “Load Mode Values”. Choose a file you wish to upload, then click “Open”. This will load the parameter values into the software. **Click the “Send All” button at the bottom of the window to write the parameters to the MND.**

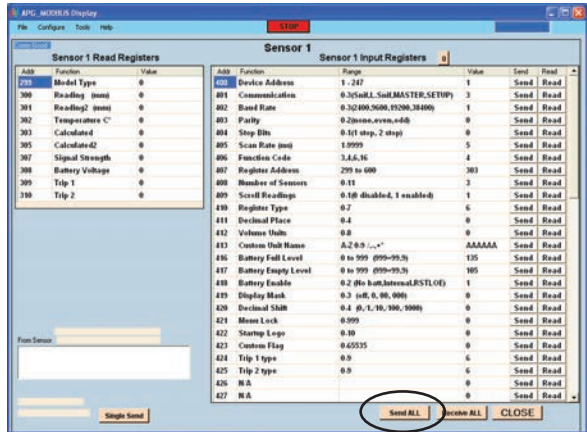
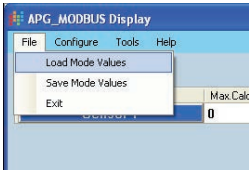

Communications Setup Examples

For APG sensors, the sensor readings are stored in register 303, which is an unsigned 32-bit register.

MND master displaying readings from a single sensor (address 1):

C-Type = Master
Number of Sensors = 1
Sensor Address = 1
Register Number = 303
Function = 4
Register Type = U32 (unsigned 32-bit)

MND master displaying multiple sensor readings, with outputs keyed to Sensor 3 (addresses 1-6):

C-Type = Master
Number of Sensors = 6
Sensor Address = 3
Register Number = 303
Function = 4
Register Type = U32 (unsigned 32-bit)

MND in Sniffer mode displaying readings from a single sensor (address 3):

C-Type = Sniffer
Number of Sensors = 1
Sensor Address = 3
Register Number = 303
Function = 4
Register Type = U32 (unsigned 32-bit)

MND displaying the readings from 2 sensors + an LOE ultrasonic:

C-Type = LOE/RST Sniffer (LRSNIF)
Number of Sensors = 2 (the LOE sensor is assumed and not included in the count)
Sensor Address = n/a (no outputs)
Register Number = 303
Function = 4
Register Type = U32 (unsigned 32-bit)

Resetting the MND to factory defaults

Simultaneously press and hold the Decrease/Power button and Enter button for approximately 5 seconds. This will bring up the 3 digit operating mode number. Change the mode number to 125 and press the enter button. This will reset all parameter values to the following factory defaults:

<u>Parameter</u>	<u>Value</u>
Units	Gallons
Auto-Off	65535 (disabled)
Decimal Place	0
Digit Mask	Off
Digit Shift	0
Multiplier	1.000
Bar Graph 0	0
Bar Graph 100	10000
Over Load	99999 (max display value)
Battery Gauge Enable	No Battery
Battery Full	13.5 V
Battery Low	11.0 V
Analog Low Reading	0
Analog High Reading	99999
Analog Low Calibration	0
Analog High Calibration	16383
T1 Type	Off
T1 Reading	1000
T1 Window	500
T2 Type	Off
T2 Reading	1000
T2 Window	500
Baud Rate	9600
Parity	None
Stop Bits	1
C-Type	Master
Sensor Address	1
Number of Sensors	1
Register Number	303
Function	4
Register Type	U32 (unsigned 32-bit)
Scan Rate	000.5 seconds
Sensor Labels	Sen 1 - Sen 11
Percent Full	00000 (disabled)

Specifications

Environmental:

Housing: IP67

Storage Temp: -40 to 160°F (-40 to 71°C)

Operating Temp: 0 to 160°F (-18 to 71°C)

Electrical:

Batteries: 9 V Lithium or 3.6 V Lithium (no outputs)

External Power: 9-28 Vdc

Physical:

Case Material: injection molded material EMI-X PDX-W-88341

4-20 mA Output:

Input Voltage Requirements: 9 Vdc min (no load) to 28 Vdc max

Signal Variance: +/-0.16 mA at set points

Output/Input: 2-wire loop-powered

Resolution: 14 bit

Protection: reversed polarity

0-3 VDC Output:

Input Voltage Requirements: 9 to 28 VDC

Signal Variance: +/-0.05 VDC at set points

Type: non-isolated 3-wire

Resolution: 14 bit

Protection: reversed polarity

Trip Point Telecom Relay Outputs:

Maximum Switched Voltage: 240 VAC or 220 VDC

Maximum Switched Current: 5A

MNU Series Ultrasonic

Input Registers (0x04):

<u>Register</u>	<u>Type</u>	<u>Returned Data</u>
30300	U16	Raw Distance/Level Reading (in mm)
30302	S16	Temperature Reading (in °C, signed)
30303-30304	U32	Calculated Reading (in selected units, no decimal)

Holding Registers (0x03):

<u>Register</u>	<u>Type</u>	<u>Description</u>	<u>Value Range</u>
40400	U16	Device Address	1 to 255
40401	U16	Units	1 to 3
40402	U16	Application Type	0-10
40403	U16	Volume Units	0 to 6
40404	U16	Decimal Place	0 to 3
40405	U16	Max Distance	0 to 10364 mm
40406	U16	Full Distance	0 to 10364 mm
40407	U16	Empty Distance	0 to 10364 mm
40408	U16	Sensitivity	0 to 100
40409	U16	Pulses	0 to 20
40410	U16	Blanking	0 to 10364 mm
40411	U16	Gain Control	0 to 4
40412	U16	Averaging	0 to 100
40413	U16	Filter Window	0 to 10364 mm
40414	U16	Out of Range Samples	0 to 255
40415	U16	Sample Rate	50 to 1000 msec.
40416	U16	Multiplier	1 to 1999
40417	S16	Offset	+/- 10364 mm
40418-40419		reserved	
40420	U16	Temperature Compensation	0 = off, 1 = on
40421-40435		reserved	
40436-40437	U32	Parameter 1 Data	0 to 100000 mm
40438-40439	U32	Parameter 2 Data	0 to 100000 mm
40440-40441	U32	Parameter 3 Data	0 to 100000 mm
40442-40443	U32	Parameter 4 Data	0 to 100000 mm
40444-40445	U32	Parameter 5 Data	0 to 100000 mm

MPX Series Magnetostrictive

Input Registers (0x04):

<u>Register</u>	<u>Type</u>	<u>Returned Data</u>
30300	U16	Raw Top Float Reading (in mm, unsigned)
30301	U16	Raw Bottom Float Reading (in mm, unsigned)
30302	S16	Temperature Reading (in °C, signed)
30303-30304	U32	Calculated Top Float Reading (in selected Units)
30305-30306	U32	Calculated Bottom Float Reading (in selected Units)

Holding Registers (0x03):

<u>Register</u>	<u>Type</u>	<u>Description</u>	<u>Value Range</u>
40400	U16	Device Address	1 to 255
40401	U16	Units	1 to 3
40402	U16	Application Type	0-10
40403	U16	Volume Units	0 to 6
40404	U16	Decimal Place	0 to 3
40405	U16	Max Distance	0 to 10364 mm
40406	U16	Full Distance	0 to 10364 mm
40407	U16	Empty Distance	0 to 10364 mm
40408	U16	Sensitivity	0 to 100
40409	U16	Pulses	0 to 20
40410	U16	Blanking	0 to 10364 mm
40411		reserved	
40412	U16	Averaging	0 to 100
40413	U16	Filter Window	0 to 10364 mm
40414	U16	Out of Range Samples	0 to 255
40415	U16	Sample Rate	50 to 1000 msec.
40416	U16	Multiplier	1 to 1999
40417	S16	Offset	+/- 10364 mm
40418-40420		reserved	
40421	S16	RTD Offset (0C)	-100 to 100
40422	U16	Float Window	0 to 1000 mm
40423	U32	Top Float Offset	+/- 10364 mm
40424	U32	Bottom Float Offset	+/- 10364 mm
40425	U32	Gain Offset	0 to 255
40426-40435		reserved	
40436-40437	U32	Parameter 1 Data	0 to 100000 mm
40438-40439	U32	Parameter 2 Data	0 to 100000 mm
40440-40441	U32	Parameter 3 Data	0 to 100000 mm
40442-40443	U32	Parameter 4 Data	0 to 100000 mm
40444-40445	U32	Parameter 5 Data	0 to 100000 mm

Notes

AUTOMATION PRODUCTS GROUP, INC.



Automation Products Group, Inc.

Tel: 1/888/525-7300

1/435/753-7300

Fax: 1/435/753-7490

e-mail: sales@apgsensors.com

www.apgsensors.com

Automation Products Group, Inc.

1025 W. 1700 N.

Logan, UT 84321