

Luminaire For Hazardous Locations

Installation and Maintenance Manual

Model L1705



Top Hi-Tech Co., Ltd.
9F, No. 1, Zhongshan Road,
Tucheng Dist, New Taipei City,
23680 Taiwan (R.O.C)

Website: www.tht-ex.com
TEL: +886-2-22671234
FAX: +886-2-22691166
e-mail: sales@tht-ex.com

Pub. Code: 201803EL1705EUS01
Subject to alterations

1. General Information

Model L1705 Series LED Luminaires are suitable for use in the following hazardous (classified) areas as defined by the National Electrical Code (NEC) and Canadian Electrical Code (CEC):

- Class I, Division 2, Groups A, B, C, D
- Class II, Division 1, Groups E, F, G

Refer to the luminaire nameplate for specific classification information, maximum ambient temperature suitability and corresponding operating temperature (T-Code).

Model L1705 Series LED Luminaire is designed for using in indoors and outdoors environment.



Rated Voltage (L1705A): 120/277Vac, 50&60 Hz
Rated Voltage (L1705C): 120/277/480Vac*, 50&60 Hz
*480Vac is only for 80W DCOB.
Ambient Temperature Range: -40°C ~ +40°C

WARNING

- ▶ To avoid the risk of fire, explosion or electric shock, this product should be installed, inspected and maintained by a qualified electrician only, in accordance with all applicable codes and regulations.
- ▶ To avoid electric shock:
 - ✓ Be certain electrical power is OFF before and during installation and maintenance.
 - ✓ Luminaire must be supplied by a wiring system required by the NEC and CEC for the specific hazardous locations with an equipment grounding conductor.
- ▶ To avoid explosion:
 - ✓ Make sure that the supply voltage is the same as the luminaire voltage.
 - ✓ Do not operate in ambient temperatures above those indicated on the luminaire nameplate.
 - ✓ All gasket seals must be clean and undamaged.
 - ✓ Before dismounting, electrical power to the luminaire must be turned off. Keep tightly closed when in operation.
- ▶ To avoid burning hands, ensure the luminaire is cool when performing maintenance.

2. Dimensions (All Dimensions in mm) –

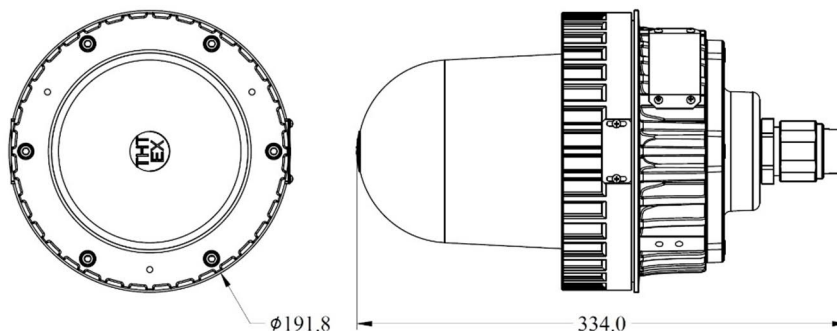

3. Technical Data

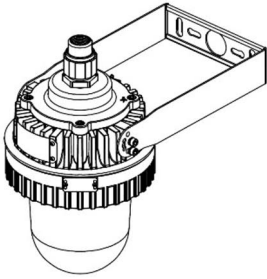
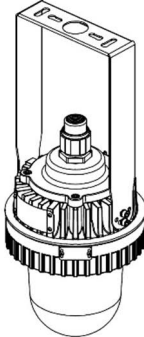
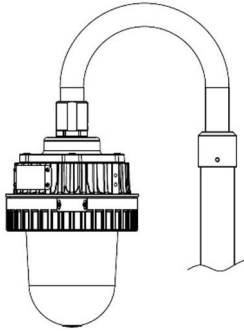
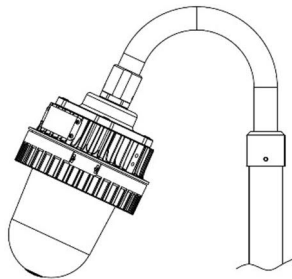
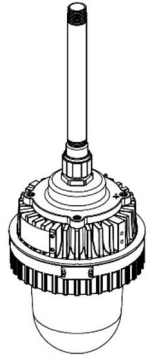
Item	Description		
Rated Voltage/Wattage	L1705A:120/277Vac, 50&60 Hz, 20W L1705C:120/277/480Vac*, 50&60 Hz, 40/50/70/80W *480Vac is only for 80W DCOB.		
Ambient Temperature Range	-40°C ~ +40°C		
Material Enclosure Glass	Aluminum alloy Heat and impact resistant tempered glass		
LED Service Life	60,000 hrs		
Mounting Type / Weight	Two-position (wall/ceiling) adjustable trunion, each position with two aiming angles		
			
	L1705A=8.5 kg L1705C=10.0 kg	L1705A=8.5 kg L1705C=10.0 kg	
	Bending electrical tube 90°	Bending electrical tube 25°	Straight electrical tube 90°
			
	L1705A=9.3 kg L1705C=10.8 kg	L1705A=9.2 kg L1705C=10.7 kg	L1705A=8.4 kg L1705C=9.9 kg

4. Assembly and Installation

4.1 Electrical Connection

Overview of Connection Base

1: Connector	2: Sleeve	3: Pressure Nut	4: Washer
5: Tube	6: M4 Screw	7: Nipple Body	8: Nipple Body Gasket

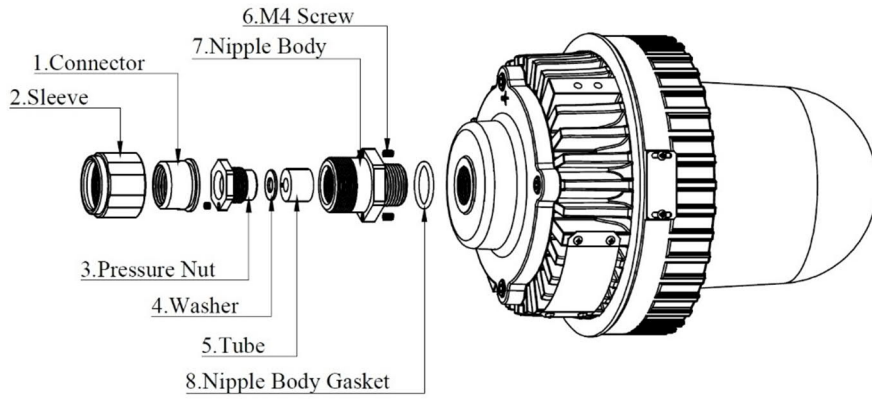

Overview of Electrical Connection

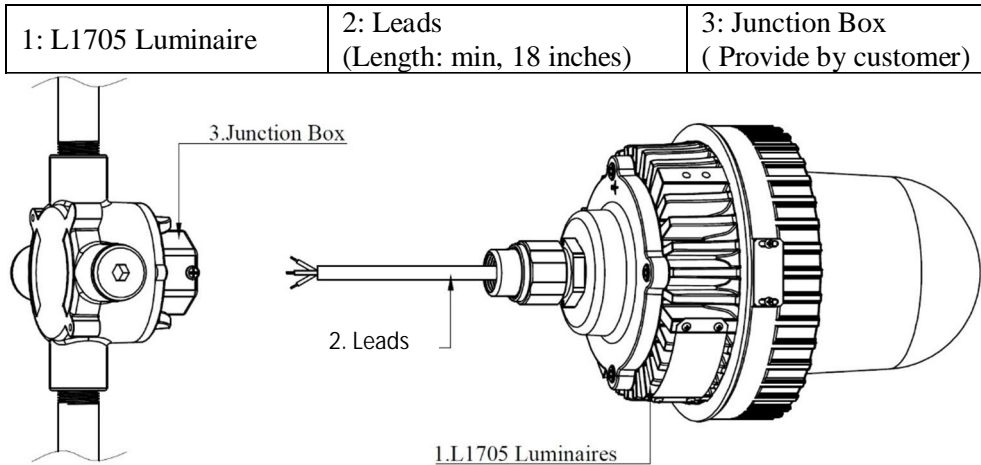

1. For luminaire model with Adjustable Trunnion (Wall/Ceiling) Mounting Bracket: Insert the leads (2) through the conduit (not shown, provide in the field) into the Junction Box (3) (provide in the field).
2. For luminaire model with Angle/Straight Bending Electrical Tube Mounting Brackets and Straight Pendant Electrical Tube Mounting Bracket: Insert the leads (2) through the integral mounting bracket and then through the conduit (not shown, provide in the field) into the Junction Box (3) (provide in the field).
3. Fix and Introduce the wires of luminaire with the terminal post of Junction Box (White-wire connects to Neutral; Red-wire connects to Live; Green-wire connects to Ground.)

4.2 Mounting Bracket Installation

4.2.1 Two Position (wall/ceiling) Adjustable Trunnion Mounting Bracket

- ☞ The mounting bracket is for surface mounting to wall and ceiling.
- ☞ Pocket holders and secured by means of the provided M6 screws, 24.5 kgf-cm. (Figures 1 and 3)
- ☞ Secure the wall mounting bracket to the mounting surface by using four fasteners (not provided). (Figures 2 and 4)
- ☞ The luminaire can be adjusted in two positions.

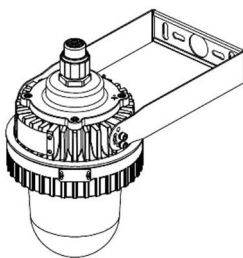

Figure 1

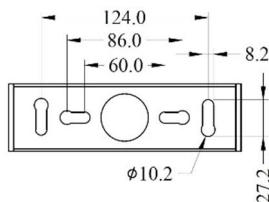

Figure 2

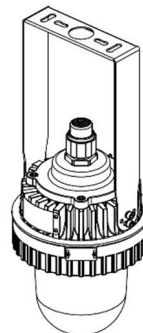

Figure 3

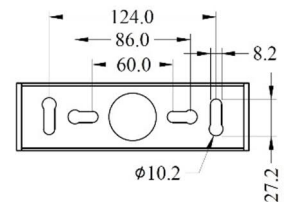

Figure 4

4.2.2 Angle/Straight Bending Electrical Tube Mounting Brackets

- ☞ The mounting type is for the use of bending electrical tube mounting.
- ☞ Tube mounting thread is 1-1/2 in. NPT for connecting with conduit in the field.
- ☞ Thread the tube mounting on conduit and torque until wrench-tight.
- ☞ Tighten tube locking set screw to conduit, 1.0 N-m. (Figures 5 and 6)

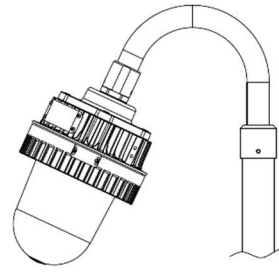

Figure 5

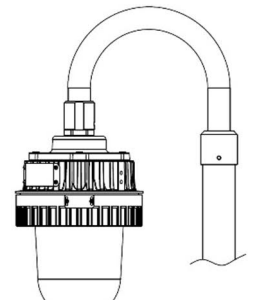

Figure 6

4.2.3 Straight Pendant Electrical Tube Mounting Bracket

- ☞ The mounting type is for the use of straight electrical tube mounting.
- ☞ Tube mounting thread is 3/4 in. NPT for connecting with conduit in the field.
- ☞ Thread the tube mounting on conduit and torque until wrench-tight.
- ☞ Tighten tube locking set screw to conduit, 1.0 N-m. (Figure 7)

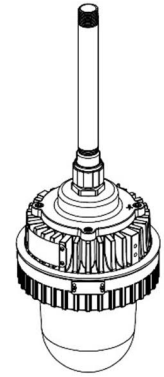

Figure 7

4.3 Putting into Service

Before putting into operating, it's necessary to ensure that:

- ☞ the luminaire is correctly installed.
- ☞ the connection has been correctly made.
- ☞ the field wiring connection has been correctly made.

5. Maintenance

- ▶ To avoid personal injury, disconnect power to the light and allow the unit to cool down before performing maintenance.
- ▶ Perform visual, electrical, and mechanical inspections on a regular basis. The environment and frequency of use should determine this. However, it is recommended that checks be made at least once a year. Frequency of use and environment should determine this. It is recommended to follow an Electrical Preventive Maintenance Program as described in the National Fire Protection Association Bulletin NFPA No. 70B: Recommended Practice for Electrical Equipment Maintenance.
- ▶ The lens should be cleaned periodically to ensure continued lighting performance. Clean the lens with a clean, damp, non-abrasive, lint-free cloth. If this is not sufficient, use a mild soap or a liquid cleaner. Do not use an abrasive, strong alkaline or acid cleaner as damage may occur.
- ▶ Inspect the cooling fins on the luminaire to ensure that they are free of any contamination (i.e. excessive dust build-up). Clean with a non-abrasive cloth if needed.
- ▶ Electrically check to make sure that all connections are clean and tight.
- ▶ Mechanically check that all parts are properly assembled.

6. Transport, Storage and Disposal

- ▶ Transport and storage is only allowed in the original packaging, on the way pointed out on the carton box.
- ▶ Transport – Shock-free in its original carton, do not drop, and handle carefully.
- ▶ Store – Store in a dry place in its original packaging.
- ▶ Disposal – Ensure environmentally friendly disposal of all components according to the legal regulations.