

SmartVue™ Process Control Monitor

Operator's Manual

Revision 12



Proprietary Notice

All rights reserved. This manual is for use by purchasers and other authorized users of the SmartVue™ Process Control Monitor. This manual may not be copied, in whole or in part, without the written consent of Dycor. Dycor reserves the right to change or improve its products and to make changes in the content of this manual without obligation to notify any person or organization of such changes or improvements. Go to www.smartvue.ca for current updates and supplemental information concerning the use of this product.

SmartVue™ is a registered trademark of Dycor Technologies Inc. and may not be used without the express written permission of Dycor.

Contact Information:

Dycor Technologies Inc.
1851 – 94 Street NW
Edmonton, Alberta
Canada T6N 1E6

Bus: 780-486-0091
800-663-9267
Fax: 780-486-3535

E-mail: sales@dycor.com

www.dycor.com

Revision Date: November 8, 2017

Copyright © 2017 Dycor Technologies Inc.

Document History

All information, illustrations, directions and specifications included in this publication are based on the latest product information available at the time of approval for printing. Dycor Technologies Inc. reserves the right to make changes at any time without notice and without incurring any obligations.

This is a working document and is subject to change. The following tables outline the revision history and approvals for this document.

Revision History

Revision	Date	Author	Notes
0	Mar, 2009	GL	Initial draft
1	May, 2009	JG	First release
2	Nov, 2009	JG	RTD temperature, process control
3	Aug, 2010	JG	Firmware Release 2.02 quick start
4	Sep, 2010	JG	Firmware Release 2.04
5	Nov, 2010	JG	Firmware Release 2.06
6	Jul, 2011	JG	Firmware Release 2.12
7	Sep, 2011	JG	Firmware Release 2.16
8	Apr, 2012	JG	Firmware Release 2.19 (a beta version)
9	Sep, 2012	JG	Firmware Release 2.26
10	Apr, 2013	JG	Firmware Release 2.30
11	May, 2016	JG	Firmware Release 2.55

Approvals

Revision	Authority	Date	Name
1	Engineering Manager	May 29, 2009	Tim Friesen
2	Engineering Manager	Dec 1, 2009	Tim Friesen
3	Engineering Manager	Aug 5, 2010	Tim Friesen
4	Engineering Manager	Sep 20, 2010	Tim Friesen
5	Engineering Manager	Nov 12, 2010	Tim Friesen
6	Engineering Manager	Jul 18, 2011	Tim Friesen
7	Engineering Manager	Sep 29, 2011	Tim Friesen
8	Engineering Manager	Apr 16, 2012	Tim Friesen
9	President/GM	Sep 12, 2012	Edgar Semler
10	President/GM	Apr 3, 2013	Edgar Semler
11	President/GM	May 25, 2016	Edgar Semler

Disclaimers/Warnings

SUITABILITY FOR USE — THIS PRODUCT IS NOT DESIGNED, AUTHORIZED OR WARRANTED TO BE SUITABLE FOR USE IN APPLICATIONS WHERE ITS FAILURE OR MALFUNCTION CAN REASONABLY BE EXPECTED TO RESULT IN PERSONAL INJURY, DEATH OR SEVERE PROPERTY OR ENVIRONMENTAL DAMAGE. DYCOR ACCEPTS NO LIABILITY FOR INCLUSION IN SUCH EQUIPMENT OR APPLICATIONS AND THEREFORE SUCH INCLUSION AND/OR USE IS AT THE CUSTOMER'S OWN RISK.

DO NOT USE THE SMARTVUE TO DIRECTLY CONTROL EQUIPMENT SUCH AS MOTORS, VALVES OR ACTUATORS NOT PROPERLY EQUIPPED WITH SAFEGUARDS.

FOR SAFTEY PURPOSES, THE EARTH GROUND TERMINAL IS ELECTRICALLY CONNECTED TO THE EXPOSED CONDUCTIVE PARTS OF THE SMARTVUE. THE EARTH GROUND CONNECTION MUST BE CONNECTED TO AN EXTERNAL EARTH GROUNDING SYSTEM.

Statement of Limited Warranty

Dycor warrants the goods sold hereunder, under normal use and service as described in the operator's manual, will be free from defects in materials and workmanship for a period of twelve (12) months from the date of delivery to the original purchaser. Any product that is found to be defective within the warranty period will, at the option of Dycor, be repaired or replaced. This limited warranty does not cover losses or damages that occur in shipment to or from Buyer or due to improper installation, maintenance, misuse, neglect or any cause other than ordinary commercial or industrial application. This limited warranty is in lieu of all other warranties whether oral or written, expressed or implied. Dycor's liability shall not exceed the price of the individual unit which is the basis of the claim. In no event shall Dycor be liable for any loss of profits, loss of use of facilities or equipment or other indirect, incidental or consequential damages.

Trademarks

Products named in this document may include copyrights, trademarks, or registered trademarks and are acknowledged as the property of their respective companies.

FCC Notification

This device complies with part 15 of the FCC rules. Operation is subject to the following two conditions: 1) This device may not cause harmful interference and 2) this device must accept any interference received, including interference that may cause undesired operation.

About This Manual

This manual covers the use of the SmartVue Process Control Monitor and is subject to change as the product is developed. It describes:

- How to use the graphic user interface
- How to connect power and inputs/outputs to/from the SmartVue
- How to configure the SmartVue and display data
- How to panel mount the SmartVue

Contents

Proprietary Notice.....	ii
Document History.....	iii
Disclaimers/Warnings.....	iv
Statement of Limited Warranty	v
Trademarks	v
FCC Notification.....	v
About This Manual	v
Contents	vi
Figures.....	ix
Tables.....	x
1.0 Introduction.....	1
2.0 Getting Started	2
2.1 Connecting Power.....	2
2.2 Starting up the SmartVue	3
2.3 The Touch Screen Interface.....	4
2.4 The Main Menu	6
2.5 Special Icons.....	9
3.0 I/O Configuration.....	10
3.1 Current Loop I/O	10
3.2 Multipurpose I/O (Digital I/O and Voltage Inputs).....	12
3.3 Total/Rate Counters.....	14
3.4 Temperature.....	15
3.5 Voltage Outputs.....	16
3.6 Frequency Outputs.....	16
3.7 4-20mA Calibration.....	17
3.8 Logic Thresholds	17
4.0 Setting Up a Process	18
5.0 Setting Up a Control Process	22
6.0 Assigning and Configuring a Meter.....	26
7.0 Setting Up an Output	31
7.1 Using the Current Loop Outputs	32
7.2 Using the Analog Voltage Outputs.....	34
7.3 Using the Frequency Outputs	34
7.4 Using the Digital Outputs.....	35
7.4.1 Threshold Mode.....	35
7.4.2 Latching Mode.....	36
7.4.3 Switching Mode.....	37
7.4.4 Fixed Outputs.....	38
8.0 Run / Stop Modes.....	41
9.0 Ethernet Data Communications	43
9.1 Ethernet Settings.....	43
9.2 Streaming Ethernet Data.....	44
9.3 Commands.....	47

9.3.1	Stream Data Start (000)	48
9.3.2	Stream Data Stop (001).....	49
9.3.3	Poll Data (002).....	49
9.3.4	Error Responses	50
9.3.5	Testing with Telnet	51
9.4	Data Output.....	52
10.0	SAE J1939 Communications.....	57
10.1	Configuration	58
10.2	Active Device List.....	60
10.3	SPN List	61
10.3.1	Add an SPN to the List.....	61
10.4	SPN (Data) Monitor	63
10.4.1	Display SPN data on the Meter Screen	63
10.5	User Device List.....	64
10.6	PGN Request List.....	65
10.7	Diagnostic Trouble Codes.....	66
10.7.1	Configuration.....	66
10.7.2	Viewing Active DTCs	67
11.0	Serial Data Communications.....	68
11.1	Streaming Serial Data.....	69
12.0	Modbus Communications.....	72
12.1	Reading Process Data.....	72
12.2	Reading J1939 Data	74
13.0	Updating the Firmware.....	76
14.0	Password Protection	78
15.0	File System	80
15.1	Saving and Loading SmartVue Settings.....	81
16.0	Data Logging	84
16.1	Data Logging Setup and Status	85
16.2	Exporting and Deleting Data Logs.....	88
16.3	Pausing Data Logging	91
17.0	SmartVue Configuration.....	92
17.1	Display Brightness	92
17.2	Touch Screen Calibration.....	93
17.3	Monitor Data	94
17.4	Date and Time	94
17.5	Information.....	95
18.0	Self-Preservation	96
19.0	Boot-up Options	97
19.1	Testing the SmartVue's Memory	97
19.2	System Information	98
19.3	LCD Brightness.....	98
19.4	Touch Calibration.....	99
19.5	Load Application.....	99
19.6	Color Bar.....	99
20.0	SmartVue Remote.....	100

20.1	Requirements.....	100
20.2	Setting Up a SmartVue for Remote Access	100
20.3	The SmartVue Remote Application	102
20.3.1	SV Remote Settings.....	103
20.3.2	Connecting/Disconnecting.....	104
20.3.3	Displaying and Capturing Screen Images	104
21.0	Appendix	106
21.1	Mechanical Drawings.....	106
21.2	Panel Mounting the SmartVue	107
21.3	Power and Signal Connections.....	108
21.4	Modbus Register Mapping	111
21.4.1	Discrete Inputs (Function Code 2 - Read Only bit).....	111
21.4.2	Input Register (Function Code 4 – Read Only 16-bit)	112
21.4.3	Input Register (Function Code 4)	114
21.4.4	J1939 SPN Input Register (Function Code 4 - Read Only).....	115
21.4.5	J1939 DTC Input Register (Function Code 4 - Read Only 16-bit)	116

Figures

Figure 2-1	External power connection.....	2
Figure 2-2	Splash screen.....	3
Figure 2-3	The Meter screen.....	3
Figure 2-4	The various keyboards for text/symbol entry.....	4
Figure 2-5	Decimal and hexadecimal keypads	4
Figure 2-6	The Main Menu screen.....	6
Figure 2-7	Block diagram of the SmartVue's menus and screens.....	8
Figure 3-1	The Configure I/O menu	10
Figure 3-2	The Current Loop I/O configuration menu	10
Figure 3-3	Configuration screens for Current Loop I/O.....	11
Figure 3-4	J1 wiring to use loop powered transmitter with power from the SmartVue	11
Figure 3-5	The Multipurpose I/O configuration menu	12
Figure 3-6	The Total/Rate Counters configuration menu.....	14
Figure 3-7	The Configure I/O - Temperature screen	15
Figure 3-8	The Configure I/O - 0-10V OUT 1 screen	16
Figure 3-9	The Configure I/O - FREQ OUT 1 screen.....	16
Figure 4-1	A basic process.....	18
Figure 4-2	J2 wiring for an RTD	20
Figure 5-1	Block diagram of a closed-loop control process.....	22
Figure 6-1	Meter screen elements.....	26
Figure 7-1	J1 wiring to use 4-20mA OUT 1 in active mode	33
Figure 7-2	J1 wiring to use 4-20mA OUT 1 in passive mode.....	33
Figure 7-3	Voltage device connected to VOUT 1	34
Figure 7-4	Frequency input device connected to FOUT 1	34
Figure 7-5	Digital output configuration screens	35
Figure 7-6	Digital output on/off behavior for Threshold mode.....	36
Figure 7-7	Set Outputs screens for latching mode with an analog input source.....	36
Figure 7-8	Pressing an <i>enabled</i> indicator button on the <i>Meter</i> screen is a convenient way to clear a latch condition.....	37
Figure 7-9	Set Outputs screen for latching mode with an digital input source.....	37
Figure 7-10	Set Outputs screens for switching mode with a digital input source	37
Figure 7-11	Output behavior for normal and inverted polarities.....	38
Figure 7-12	J1 and J2 wiring to use 4-20mA OUT 1 as external setpoint control source.....	39
Figure 8-1	The Run / Stop menu.....	41
Figure 8-2	The Meter screen the <i>Stop Process Control</i> mode is engaged.....	41
Figure 8-3	The Meter screen the <i>Disabled Configuration</i> mode is engaged.....	42
Figure 9-1	The Ethernet Settings screen.....	44
Figure 9-2	Ethernet Settings - Data screen	45
Figure 9-3	Ethernet Settings – Configure Auto Send screen.....	45
Figure 10-1	The J1939 menu	58
Figure 10-2	J1939 Configuration with an address type of <i>Arbitrary</i>	58
Figure 10-3	J1939 Configuration with an address type of <i>Fixed</i>	58
Figure 10-4	The J1939 Active Device List.....	60
Figure 10-5	Active Device Info screen.....	60

Figure 10-6	The SPN (Data) Monitor screen.....	63
Figure 10-7	The Active DTC Monitor screen.....	67
Figure 11-1	RS232 Settings.....	69
Figure 11-2	RS232 Settings – Configure Auto Send screen.....	70
Figure 11-3	Serial communications using PuTTY.....	71
Figure 11-4	Sample serial data using PuTTY.....	71
Figure 12-1	RS232 Settings with MB RTU serial mode.....	72
Figure 15-1	The File System menu.....	80
Figure 16-1	The Data Logging menu.....	84
Figure 16-2	Data Logging Settings screen.....	85
Figure 16-3	The Data Logging Status screen.....	88
Figure 17-1	Brightness configuration screen.....	92
Figure 17-2	Touch Screen Calibration screen.....	93
Figure 17-3	The Monitor Data screen.....	94
Figure 17-4	Date / Time screen.....	94
Figure 17-5	The Information screen.....	95
Figure 19-1	The Boot Menu.....	97
Figure 19-2	The Flash ROM test will require that the application firmware be reloaded.....	97
Figure 19-3	Boot loader System Information screen.....	98
Figure 19-4	Boot loader LCD Brightness adjustment screen.....	98
Figure 19-5	Boot loader Touch Calibration screen.....	99
Figure 19-6	Boot loader Color Bar screen.....	99
Figure 20-1	The Ethernet Settings screen.....	100
Figure 20-2	The Ethernet Settings - Remote GUI screen.....	101
Figure 20-3	Link icons.....	102
Figure 20-4	The SmartVue Remote program window.....	102
Figure 20-5	<i>SmartVue Remote</i> displaying a remote screen.....	105
Figure 21-1	Panel mounting cutout dimensions.....	106
Figure 21-2	SmartVue dimensions.....	106
Figure 21-3	SmartVue installation – exploded view.....	107
Figure 21-4	SmartVue installed in panel.....	107
Figure 21-5	Rear view of the SmartVue with terminal block layout.....	108

Tables

Table 2-1	Special keyboard keys.....	5
Table 2-2	The Main Menu.....	6
Table 4-1	SmartVue Process Types.....	18
Table 6-1	RTD Error Messages.....	30
Table 10-1	Status lamps and their meanings.....	67
Table 12-1	DTC Modbus register mapping.....	75
Table 21-1	SmartVue Terminal Block Pinout.....	108

1.0 Introduction

This manual describes the operation of the SmartVue™ Process Control Monitor and covers the use of the embedded firmware through to version 2.40. The appendix describes the panel mounting installation for the SmartVue and summarizes the terminal connections.

The SmartVue displays the values for selected input signals according to user definable scales. Up to four separate meters can be displayed simultaneously on its 3.5-inch LCD screen. It is easily configured using an intuitive graphical interface that is navigated using its touch screen. Settings may be permanently stored in the device's memory and it will start up with its last saved configuration.

The SmartVue's compact size, easy-to-use interface and versatility make it an effective tool for control and monitoring in a variety of industrial applications.

The SmartVue operates around the concept of a user defined *process* that receives an input in the form of an externally connected electrical signal and optionally generates an output signal according to a set configuration. The input signals can be scaled and displayed on the Meter screen with meaningful units. Likewise the output signal can also be scaled to conform to the requirements of an externally connected device.

2.0 Getting Started

2.1 Connecting Power

To power up the SmartVue so you can begin configuring it, an external power supply is needed. The SmartVue requires a 10 to 30 VDC, externally fused power source, connected to J4-1 (positive) and J4-2 (ground). To protect the unit from potential electrostatic discharge, J4-3 (EARTH) should be connected to the metal surface of the mounting enclosure.

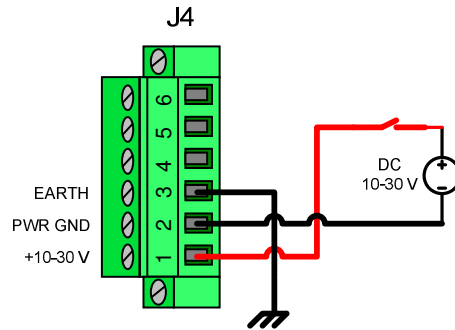

Figure 2-1 External power connection

The power connections are also listed in Table 21-1.

2.2 Starting up the SmartVue

When the SmartVue is powered on you will briefly see a splash screen (Figure 2-2) displaying the boot loader version number, serial number, model number, manufacture date, and MAC address of the unit along with some other startup messages.

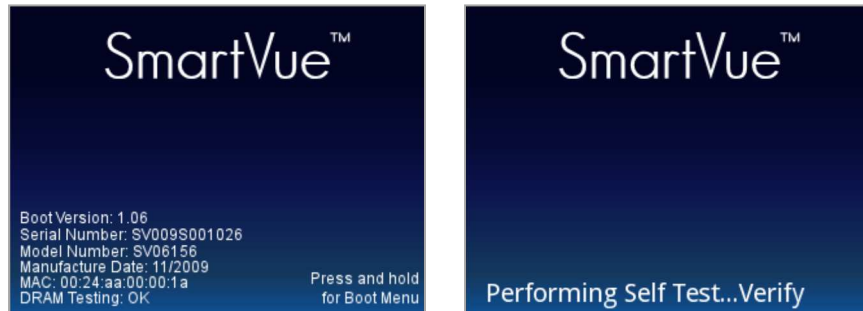

Figure 2-2 Splash screen



Special startup options

You can override the SmartVue's normal startup if you press and hold on the touch screen while the unit is powered on. This will display the *Boot Menu* described in Section 19.0. The *Boot Menu* displays options for running memory diagnostics, configuring the LCD brightness, calibrating the touch screen and updating the firmware version.

Once the unit's self-test is completed the *Meter* screen will be displayed. A few examples of the *Meter* screen are shown in the figure below.

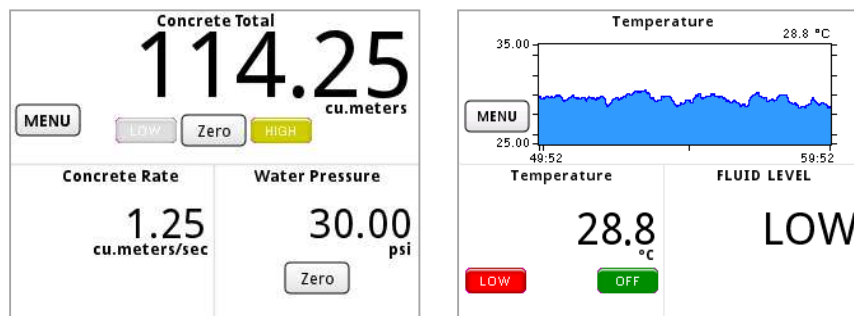

Figure 2-3 The Meter screen

The *Meter* screen displays up to four meters so that the input data you provide to the SmartVue can be easily read. Depending on the type of process you have assigned to a meter and various meter configuration options, you may also see buttons or threshold indicators on a given meter. Indicators can also display the status of digital I/O points.

Pressing the MENU button will take you to the *Main* menu screen.

2.3 The Touch Screen Interface

The LCD display is overlaid with a touch screen which provides the means for user interaction with the software. Button activation, text, and numerical entry are all achieved by touching, or pressing, the related graphic representation. When a textbox designed for character entry is pressed, a keyboard will be displayed (Figure 2-4). Likewise, when a textbox meant for numerical entry is pressed, a numerical keypad (either decimal or hexadecimal) is displayed (Figure 2-5).

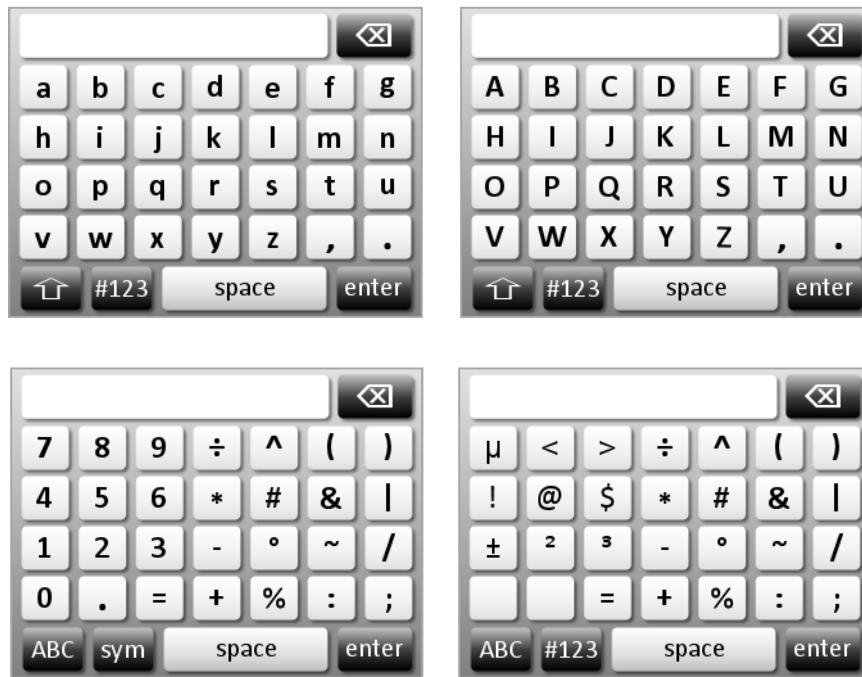







Figure 2-4 The various keyboards for text/symbol entry



Figure 2-5 Decimal and hexadecimal keypads

Table 2-1 Special keyboard keys

	Backspace
	Toggle between upper and lower case
	Displays a combined numeric and symbol keyboard
	Display a symbols only keyboard
	Enter the value into the selected text/numeric field

2.4 The Main Menu

Pressing the MENU button on the *Meter* screen will display the *Main Menu* shown in Figure 2-6. From here you can navigate the SmartVue's various menus and configuration screens. A block diagram showing the menu hierarchy is shown in Figure 2-7. A summary of the *Main Menu* items is listed in Table 2-2.

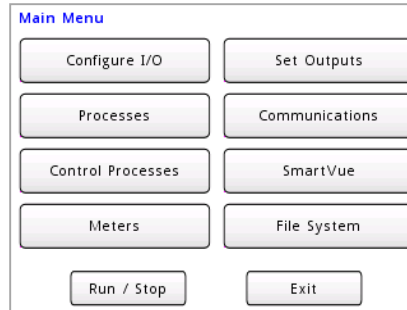

Figure 2-6 The Main Menu screen

Table 2-2 The Main Menu

Main Menu Button	Description
Configure I/O	Allows configuration of the default settings for all of the SmartVue's inputs and which multipurpose I/O points will be used for outputs. It also provides access to the 4-20mA calibration and logic threshold settings.
Set Outputs	Provides options for assigning one or more of the SmartVue's outputs to a process and setting output scaling factors.
Processes	Displays a menu of currently assigned and/or disabled processes that you can configure to use a SmartVue input.
Communications	Displays a menu that allows various communications protocols to be configured including Ethernet and J1939-11.
Control Processes	Displays a menu of currently assigned and/or disabled control processes that you can configure to use a SmartVue input.
SmartVue	Provides access to the password protection system, display configuration, data monitoring, and the firmware uploading feature.
Meters	Allows you to assign a process to a meter for display on the Meter Screen. It also allows configuration for data averaging, and meter limit indicators.
File System	Displays a menu of file system operations allowing you to save your current configuration changes or load a preconfigured set of processes, meters, and I/O configuration settings. Note: if you load the default settings and then press <i>Save Settings</i> your own settings will be overwritten with the built-in defaults.
Run / Stop	Provides options for controlling the SmartVue's operational modes for processes and outputs.

Note, you may experience a slight delay when exiting the *Main* menu to return to the *Meter* screen when one or more history graphs is being displayed since the buffered history data must be read in order to render the graphs.

A small lock icon is displayed next to each block for a screen that can be locked, and thus made inaccessible when password protection is turned on. Refer to Section 14.0 *Password Protection* for more information.

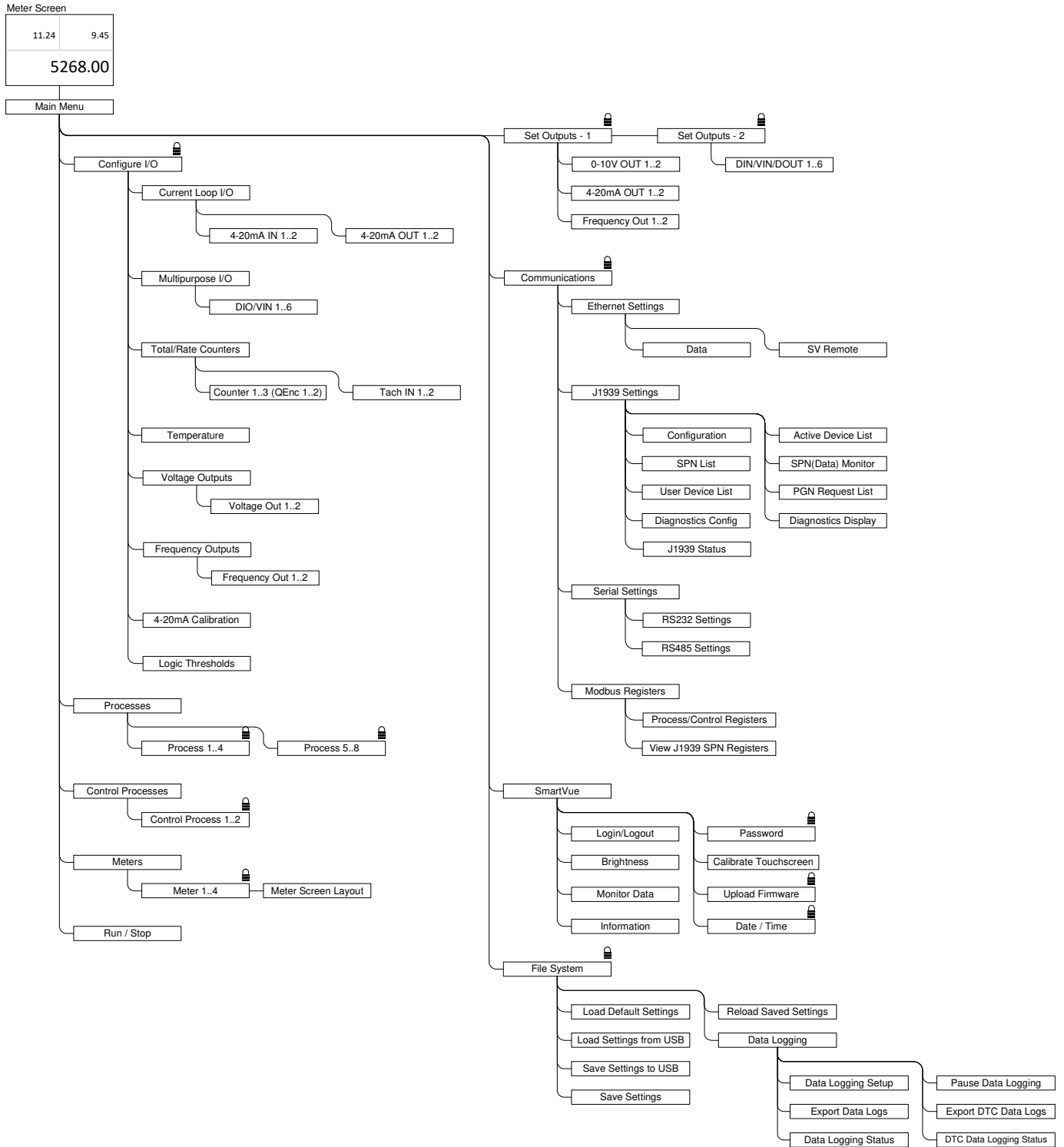













Figure 2-7 Block diagram of the SmartVue's menus and screens

2.5 Special Icons

One or more icons may be displayed in the upper right-hand corner of the screen for a number of conditions. They are summarized in the table below.

Icon	Description
	There are unsaved configuration changes
	A remote connection has been established
	A remote connection has been established and local touch screen control has been disabled
	The main password has been set and the user is logged in
	The main password has been set and the user is logged out preventing access to certain configuration screens
	One or more active DTCs has been detected on the J1939 bus
	A process configuration change has affected one or more associated outputs disabling it – it must be reviewed and manually re-enabled
	Data logging is enabled
	Data logging is paused
	The data logging memory is full
	The data logging memory is full and paused

3.0 I/O Configuration

The I/O configuration feature of the SmartVue allows you to specify default settings for the inputs and outputs and how certain I/O points will function. For example, the multipurpose I/O points can each be independently configured to work as an analog input, a digital input, or a digital output.

If you have an I/O setup that you will use on a regular basis, you may wish to configure the SmartVue's I/O points with that setup in mind so that it is available as the default. When setting up a process, you have the option of using the *Load Defaults from IOConfig* button to load default values setup in the *Configure I/O* options described below.

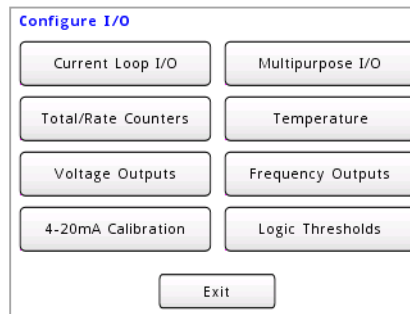

Figure 3-1 The Configure I/O menu



Remember to save your settings!

If the power is shut off to the SmartVue, any changes you make to the configuration will be lost unless you save your settings first. A small diskette icon will appear in the upper right of the screen to remind you that you have unsaved changes. On the Main menu press *File System* and then *Save Settings*.



3.1 Current Loop I/O

The SmartVue's two current loop inputs and two current loop outputs can be set with a default configuration. The Current Loop I/O configuration menu, shown below displays a menu for each current loop I/O point.

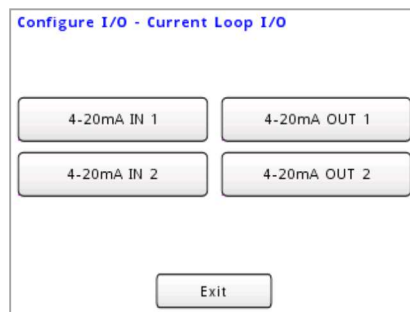

Figure 3-2 The Current Loop I/O configuration menu

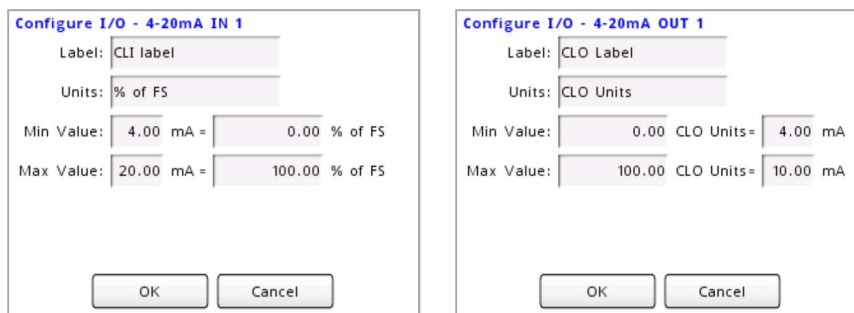

Figure 3-3 Configuration screens for Current Loop I/O

The current loop I/O configuration settings are summarized as follows:

- Label** The identifying label that will appear on the meter screen.
- Units** The engineering units the value will be displayed with.
- scale values** The minimum and maximum expected current values and corresponding engineering values for determining scaling. For a current loop input the values on the left represent the expected range of current values that the SmartVue may receive from a sensor or some other device. For an output, the values on the right represent the expected range of currents that the unit will provide to an external device. In either case, current values may exceed the given range since the values are merely used to calculate corresponding scaled values.

Example: Connect a loop powered transmitter using the SmartVue as the power source.

In this example a current loop device connected to 4-20mA IN 1, requiring loop power, receives it from the SmartVue's built-in supply.

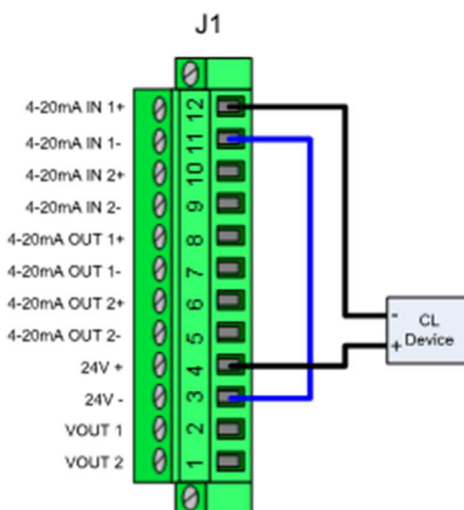

Figure 3-4 J1 wiring to use loop powered transmitter with power from the SmartVue

3.2 Multipurpose I/O (Digital I/O and Voltage Inputs)

The SmartVue is equipped with six channels that can each independently function as a digital input, digital output or analog voltage input designed for an input range of 0 to 10 volts. When you navigate to the *Multipurpose I/O* configuration menu (shown below) the buttons indicate the currently configured I/O type for each channel in parentheses. An assortment of I/O types is preset on the SmartVue.

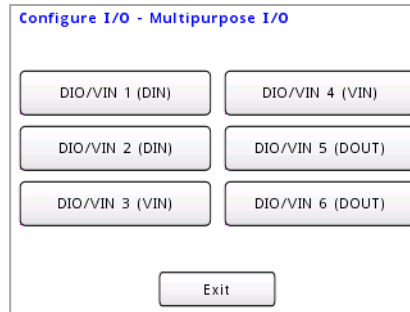

Figure 3-5 The Multipurpose I/O configuration menu

➤ **To configure a Multipurpose I/O channel**

1. Press **MENU > Configure I/O > Multipurpose I/O**.
2. Press the button for the channel (DIO/VIN 1 to 6) that you wish to configure.
3. Choose the desired I/O type: **Digital Input, Digital Output** or **Voltage Input**.
4. Configure the I/O channel:

Digital Input/Output

Label	The identifying label that will appear on the meter screen.
Low State	The characters that will be displayed on the meter screen for a low digital input signal.
High State	Digital Input: The characters that will be displayed on the meter screen for a high digital input signal.
HiZ State	Digital Output: The characters that will be displayed on the meter screen when the output is in a high impedance state.
Pull-up	Turns the pull-up resistor on or off for the given digital input or output.

Voltage Input

Label	The identifying label that will appear on the meter screen.
Units	The engineering units that the input voltage will be scaled to represent.
<i>scale values</i>	The minimum and maximum input voltages and corresponding engineering values.

5. Press **OK**.

3.3 Total/Rate Counters

The SmartVue is equipped with three *Total/Rate Counters* whose inputs can also double as possible quadrature input counters. Two tachometer inputs are also available. As the name indicates, there are two quantitative elements: total and rate, either of which may be chosen for display on the *Meter* screen with their own distinct label and unit settings. You could also choose to display the total on one meter and the rate on another.

The *Total/Rate Counters* configuration menu is shown in Figure 3-6.

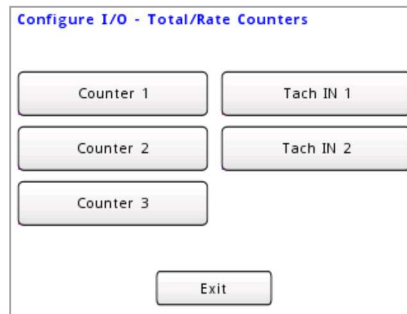

Figure 3-6 The Total/Rate Counters configuration menu

The *Total/Rate Counters* configuration settings are summarized as follows:

K Factor	A scaling value by which the count value is divided in order to convert the input pulses to engineering units.
Label	The identifying label that will appear on the meter screen.
Units	The engineering units the value will be displayed with.
Time Base	Use to set the period of time over which counting will take place.
Pull-up	If needed, pull-up resistors can be enabled for the counters, the tachometers do not require them.
Mode	(Counter 3 only) Counter 3 can be configured to operate as a regular counter or as a quadrature counter. The possible modes are Counter , Quad x2 and Quad x4 .

3.4 Temperature

Default configuration settings for the RTD temperature sensor input are set using the *Configure I/O - Temperature* screen shown below. These defaults merely represent the values that will be used when a new temperature process is created so that a process can be set up more quickly. This assumes, of course, that the default settings are ones that you use most often. In the case of a temperature process, the Label and Unit settings can be conveniently loaded from the defaults when you later set up a process that uses them.

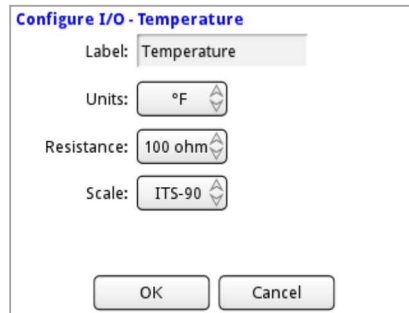

Figure 3-7 The Configure I/O - Temperature screen

The temperature configuration settings are summarized as follows:

- Label** The identifying label that will appear on the meter screen.
- Units** The temperature scale and units the value will be displayed with: °C, °F, K for Kelvin.
- Resistance** This should correspond to the resistance specification of the RTD being used. The SmartVue supports 100 and 500 ohm sensors.
- Scale** This is the thermodynamic temperature scale applied as the standard by which measured values from the sensor will be converted to a practical temperature scale like °C or °F. The more modern ITS-90 scale is more accurate, but the simpler IPTS-68 is still used for some industrial applications since it still gives acceptable accuracy.

3.5 Voltage Outputs

Settings for the two voltage outputs (0-10V OUT 1 and 2) may be made to provide between 0 and 10 volts based on a scale you provide for a device you wish to control. In the example below, a 0.00 bar pressure is equal to a 1.00 volt output on 0-10V OUT 1 while 20.00 bar equates to an output of 10 volts.



Configure I/O - 0-10V OUT 1

Label: Pressure

Units: bar

Min Value: 0.00 bar = 1.00 V

Max Value: 20.00 bar = 10.00 V

OK Cancel

Figure 3-8 The Configure I/O - 0-10V OUT 1 screen

3.6 Frequency Outputs

Like the voltage outputs, the frequency outputs can be configured with desired labels, units and scales to work in conjunction with a process that provides a square wave output to a device. The screen below shows a possible setup.

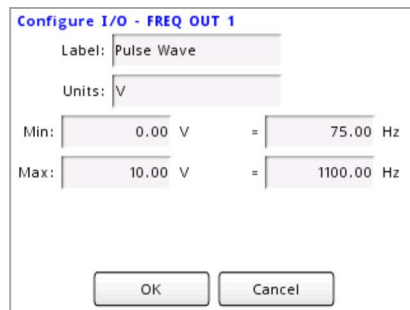

Configure I/O - FREQ OUT 1

Label: Pulse Wave

Units: V

Min: 0.00 V = 75.00 Hz

Max: 10.00 V = 1100.00 Hz

OK Cancel

Figure 3-9 The Configure I/O - FREQ OUT 1 screen

3.7 4-20mA Calibration

To ensure the precise accuracy of the current loop input measurements, the 4-20 mA current loop input channels can be independently calibrated. With a known 4 mA source supplied to a current loop input, the raw, unconverted value supplied by the analog-to-digital convertor can be read and set as the corresponding reference for that current level. Finally, the raw value read when a 20 mA source is supplied to the same input will calibrate the current loop input channel range characteristic.

➤ **To calibrate a 4-20 mA Current Loop Input**

1. Press **MENU > Configure I/O > 4-20mA Calibration** to display the following screen.

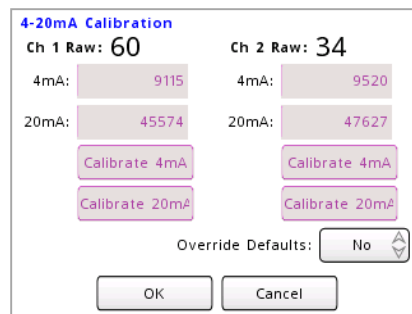

2. Connect a power supply that delivers 4 mA of current to the 4-20mA current input you wish to calibrate (4-20mA IN 1 or 2) and then press the **Calibrate 4mA** button to set the measured raw current value as the calibrated reference for 4 mA.
3. Likewise, set the supply to deliver 20 mA and then press the **Calibrate 20mA** button to set the raw value as the calibrated reference for 20 mA.
4. Press **OK**.

3.8 Logic Thresholds

The logic thresholds define the voltage levels at which a low state will transition to a high state and vice versa. A threshold level for the six DIO/VIN points on the J2 terminal block can be configured. Likewise, the quadrature/counter inputs together with the two frequency outputs (indicated by QENC and FRQ OUT on the terminal block legend) can also be configured with a particular threshold level.

➤ **To adjust the logic thresholds**

1. Press **MENU > Configure I/O > Logic Thresholds**.
2. Enter a value for the **DIO/VIN** logic threshold between 0 and 30 volts.
3. Enter a value for the **QENC/FRQ** logic threshold between 0 and 30 volts.
4. Press **OK**.

4.0 Setting Up a Process

For the SmartVue, a *process* is simply defined as the continuous acquisition of a measurable signal or user supplied value (an input) that can be displayed in a meaningful way with quantifiable units. The input value may in turn be used to control one or more outputs. A process can also be assigned to a meter (or even multiple meters) so it can be displayed on the Meter Screen.

Keep in mind that the SmartVue makes a distinction between two types of processes: (basic) *processes* and *control processes*. A control process incorporates feedback for closed-loop control. In this section we will discuss the basic process that does not incorporate feedback.

The block diagram below shows the SmartVue's functional components for a basic process. The dashed blocks indicate an optional setup for a process.

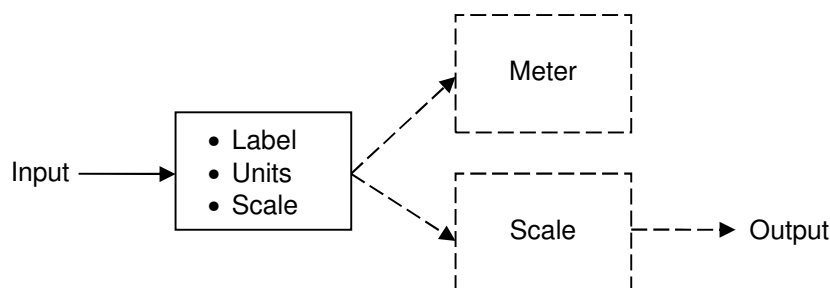

Figure 4-1 A basic process

The SmartVue allows up to eight processes and two control processes to be configured. The types of processes that can be configured are summarized in Table 4-1.

Table 4-1 SmartVue Process Types

Process Type	Input	Modes
Total/Rate	Counter 1	Counter or Quad x2, x4; Pull-up: On/Off
	Counter 2	Pull-up: On/Off; Used as QEnc-B input when Counter 1 is set to Quad mode
	Counter 3/QEnc 1	Counter or Quad x2, x4; Pull-up: On/Off
	Tach IN 1..2	
Current Loop Input	4-20mA IN 1..2	
Temperature	n/a	100 Ω or 500 Ω RTD (3-wire)
Multipurpose I/O	DIO/VIN 1..6	Any combination of digital inputs, digital outputs, or analog voltage inputs (0-25 V)
J1939 SPN	Active SPN	
Process Control	Control 1	PID, PID with external setpoint
	Control 2	PID, PID with external setpoint

➤ **To create a new process or edit an existing process**

1. Select **MENU > Processes**. This will display the menu of processes that are currently assigned or disabled. Any existing process can be edited if it is not locked. Press a button corresponding to a process you wish to create. Use the arrow buttons to configure up to eight processes.

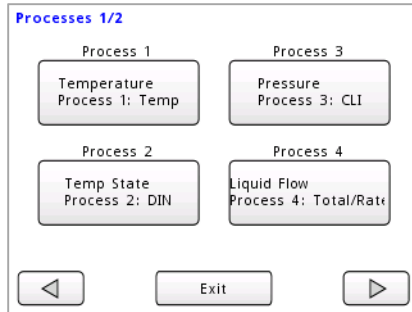

2. Choose a Name, Type, and Input point for the process.

- **Name** – Enter a name for your process to uniquely identify it (up to 20 characters).

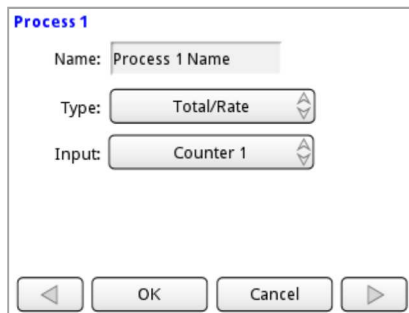

Press either the right or the left arrow button to advance to the next configuration screen. The type of configuration screen that is displayed will depend on the input type you select.

- **Type** – Select a process type suitable for the sensor that you have connected to the SmartVue (Total/Rate, Current Loop Input, Temperature (RTD), Multipurpose I/O (digital or voltage input), or J1939 SPN).
 - **Input** – Select an input point/channel that will supply the measured value.
 - **Label, units, other settings** – Enter a label and engineering units that will appear on the Meter Screen. To quickly load previously defined values are not what you want to use, press the **Load Settings from IOConfig**.
3. Press the left or right arrow button to advance to the next configuration screen for the process. Note: the selected input type will determine the kind of configuration screen that will be displayed.
 4. Other parameters:
 - **Scale (analog inputs)** – Minimum and maximum scaling factors are used so that the measured signal values can be converted to real-world engineering values.
 - **K Factor (counters)** – A scaling value by which the count value is divided in order to convert the input pulses to engineering units.

- **Time base (counters)** – Use to set the period of time over which counting will take place.
 - **Low/High states (digital inputs)** – Short text messages displayed on the meter depending on the high or low state of the selected digital input.
5. Press **OK**.

When a process is created its name appears on its corresponding button on the Processes menu screen. If a button displays the word “Disabled” then it will not acquire a signal from its respective input and any meters assigned to it will not be displayed on the Meter screen.



The red exclamation point

By now you may have discovered that when you change one part of a process, it can have an effect on another. In that case you may see a red exclamation point in the upper right corner of the screen or on certain buttons indicating that some configuration settings may no longer be valid or a change may have affected (and possibly disabled) an output. If this happens confirm that your configuration is correct by verifying or changing the affected settings.



Example: Set up a Temperature Process Using an RTD (Resistance Temperature Detector)

1. Connect a 100 ohm or 500 ohm RTD (3-wire) to the J2 terminal connector as shown in Figure 4-2. The temperature sensor may, of course, be connected to the end of a long cable so that it is located in a spot where you wish to make an accurate temperature measurement.

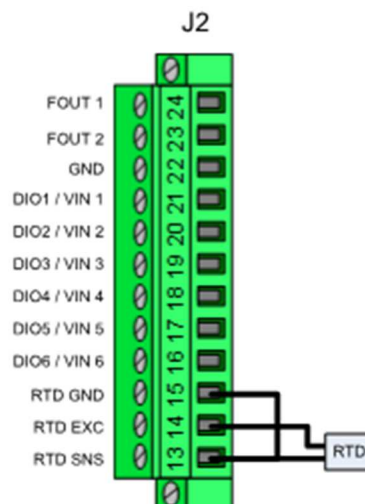
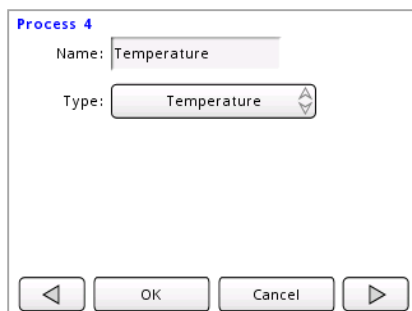

Figure 4-2 J2 wiring for an RTD

2. Select **MENU > Processes** to display the **Processes** menu.

3. Press the button for an unused process (or a process you don't mind reconfiguring).
4. Enter a name for the Process (e.g. "Temperature"), then select **Temperature** using the **Type** spinner button. Your screen should now look like the one below. (In this case password protection is shut off so no Lock button is displayed.)



5. Press an arrow button to advance to the next setup screen. This will display a screen similar to the one below. Defaults, which you may define yourself, can be loaded from the I/O Configuration options by pressing the **Load Settings from IOConfig** button. (Refer to Section 3.0 *I/O Configuration* for setting up default I/O configurations.)

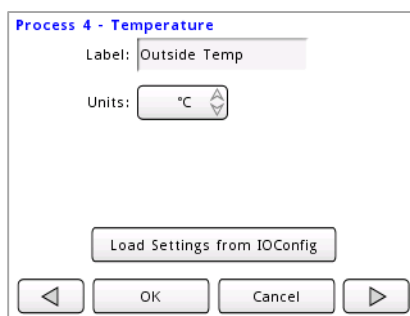
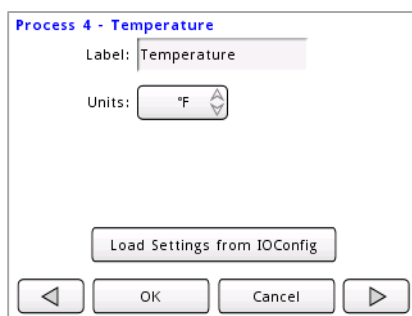

6. Press **OK**.
7. While you could look at the *Monitor Data* screen to observe your temperature measurements right away, you will likely want to display this information on the Meter Screen. The example in Section 6.0, *Assigning and Configuring a Meter*, will show you how to do just that.

Notes

- The RTD value displayed on the *Monitor Data* screen will be with the units configured using the Configure I/O, Temperature screen and is not affected by the process configuration.
- If a fault occurs with the RTD sensor (such as a disconnection), any enabled output that is tied to the associated process will be disabled if the output is set to *auto disable*. The output must be manually re-enabled after the fault has been corrected.

5.0 Setting Up a Control Process

Like a process, a *control process* incorporates the continuous acquisition of a measurable signal. In this case, however, an output value (called the *modified variable*) is required so that changes to the process being controlled can be measured via a *feedback* sensor and an error value (the difference between the user specified setpoint and the measured input value being fed back) can be computed. The result is subsequently supplied to a PID control algorithm so that the error value can be minimized over time. The block diagram below shows how the various aspects of a control process work together.

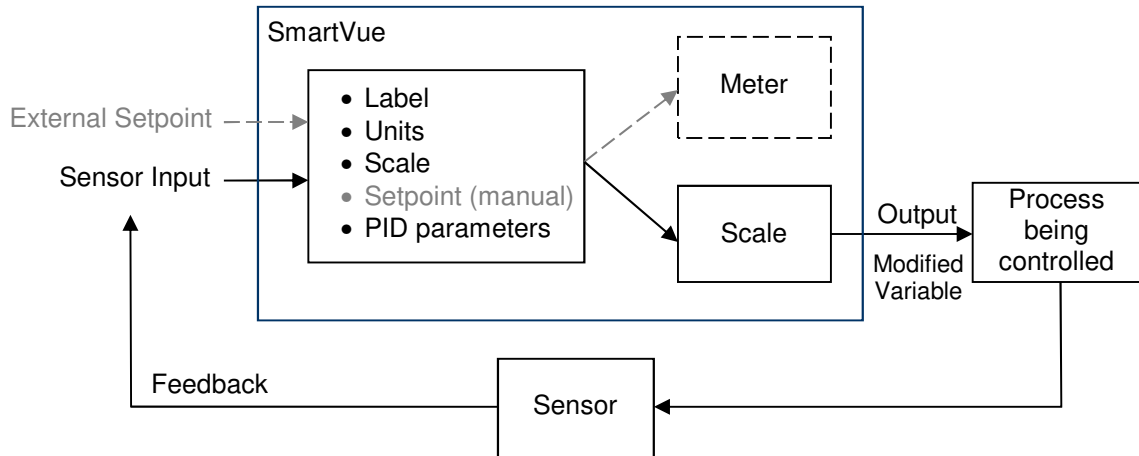

Figure 5-1 Block diagram of a closed-loop control process

In addition to the modified variable, various other parameters for a control process can be assigned to a meter so it can be displayed on the *Meter* screen including: the feedback variable, the error value, and the setpoint value. The control process input value can, of course, also be chosen for display.

You also have the choice of using either a manually entered setpoint or an external setpoint that is governed by the signal connected to one of the SmartVue's inputs.

Setting up a control process is similar to setting up the basic process explained earlier. The instructions below describe the procedure for setting up the control process while the output setup is described in Section 7.0 *Setting Up an Output*.

➤ **To create a new, or edit an existing Control Process**

1. Select **MENU > Control Processes**. This will display the menu of control processes that are currently assigned or disabled. Any existing control process can be edited if it is not locked. Press a button corresponding to a control process you wish to create or edit.

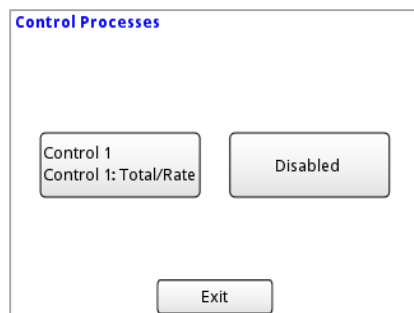

2. Define the control process

- **Name** – Enter a name for your process (up to 20 characters), then select a process type and an input point that will supply the measured value.
- **Mode** – Choose the control mode.
 - **PID** – Closed loop PID control with a manually entered setpoint value.
 - **PID Ext SP** – Closed loop PID control that uses an analog or counter input to set the setpoint.
 - **Disabled** – The Control Process and its associated output are disabled.*

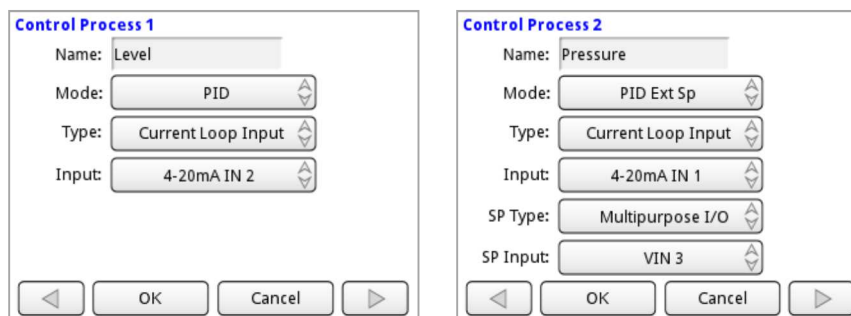

- **Type** – Select the type of input that will serve as the sensor feedback signal.
- **Input** – Select the input channel for the specified feedback type.
- **SP Type** – (Displayed only if the Mode is PID Ext SP.) Select the type of input that will serve as the setpoint signal.
- **SP Input** – (Displayed only if the Mode is PID Ext SP.) Select the input channel for the specified setpoint type.

3. Press the right arrow button to proceed to the feedback input scale configuration.

* The output is set to its prescribed non-active state: voltages and frequencies are set to zero, current outputs are set to 3.8 mA, and digital outputs will be high.

4. **Feedback label, units, scale** – If you have pre-configured IO units and scales values that you want to use for the selected input type, press the **Load Settings from IOConfig** button to load them. Enter a label and engineering units that will appear on the Meter Screen then enter scaling values for the input signal so that the displayed values accurately reflect the value being measured for the engineering units you have chosen.

Note that input scaling values will not be applied to the control process computation algorithm until either **Apply** (see below) or **OK** are pressed.

5. If the control mode is **PID Ext SP**, the next screen will be the setpoint scale configuration which is configured as described in the previous step. Proceed to the next screen.
6. **PID Parameters:** Enter values for the **Setpoint** (*PID* mode only), the PID coefficients, **Kp**, **Ki**, and **Kd**, as well as **Imax**, **Imin**, and the **Sample Interval**.

Adjust the PID parameters and click **Apply** or **OK** to update the control process. You can *tune* your control process by using the Apply button and observing the effects on the Feedback, Error, and Modified values.

K_p , K_i , and K_d are the PID algorithm coefficients or gains. I_{max} and I_{min} set limits for the I term, preventing it from becoming too large and are specified in engineering units for the process output. The values you choose depend on the capability of the system being controlled. For example, if your system is controlling a pump rated for 15 gallons per minute, then I_{max} should be set to 15.00 and I_{min} to -15.00.

The valid range for the *Sample Interval* is 20 to 10000 milliseconds. A slower system that is less sensitive to random disturbances or parameter variations does not need to be sampled as often.

You can observe the effects of adjusting the PID parameters on the Feedback, Error, and Modified values on this screen and thus *tune* the control process by using the **Apply** button.

7. Press **OK**.
8. Setup an output using the procedure outlined in Section 7.0.

Notes

- Data for the RTD temperature inputs is acquired every 1500 ms while data for the Total/Rate inputs is acquired every 100 ms.
- The setpoint units will be display in red on the PID Parameters screen if they do not match the feedback units. The closed-loop error value is computed by determining the difference between these two values.

6.0 Assigning and Configuring a Meter

The meter screen displays data for up to four meters simultaneously with a variety of layout options. Note that while you may usually want to display data for an input on the *Meter* screen it is not a requirement and the process will still run.

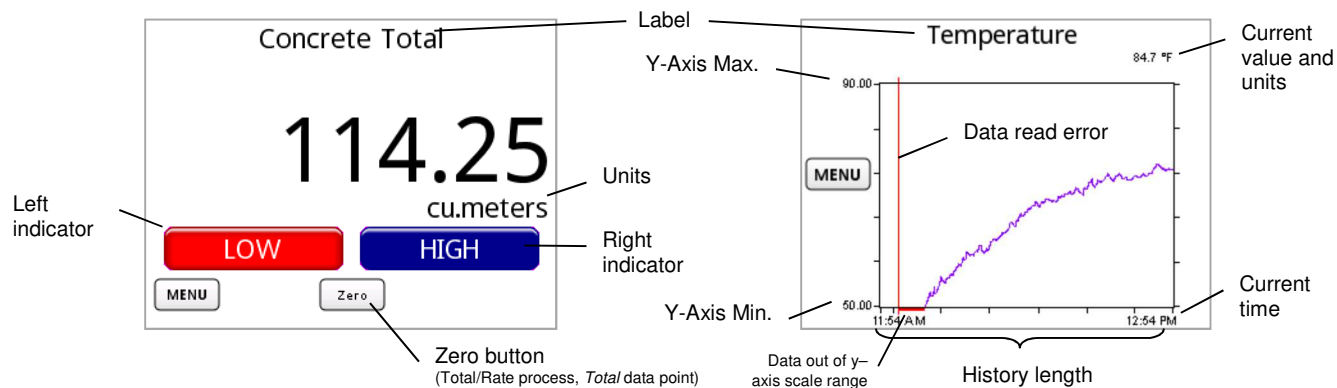

Figure 6-1 Meter screen elements

Any meter can be configured to display sampled data in one of two forms: a digital meter or a history graph. A digital meter displays data numerically while a history graph displays an historical line graph allowing a trend to be observed over a specified period of time.

Digital meters can also be configured to control indicators for specified limit values. When a limit value is reached you can have it turn on a *High* or *Low* indicator on the meter and even latch at that state. These indicators can also act as buttons to configure threshold values. The limit values can also be used to control the state of a digital output. If you want to control a digital output based on the value of a certain input you can set the same or different values using the *Set Outputs* configuration for a digital output. Refer to Section 7.0 *Setting Up an Output*.

The history graph will display a red vertical line if there is an error reading an incoming data value. This can occur just after the unit has been powered up and the signal conditioning firmware is also just starting up. If the data is outside of the plot range for the chosen y-axis scale, then a red line along the horizontal axis will be displayed. If this situation is persistent then you will need to alter your y-axis settings. These lines will appear gray if the chosen data line color is red.

Note

- When exiting from the main menu to return to a *Meter* screen that displays a history graph you may notice a delay of several seconds while the stored data for the graph is loaded from memory.

➤ **To assign a process to a meter**

1. Select **MENU > Meters**. The *Meters* menu is displayed showing a button for every meter position available given the currently select layout.

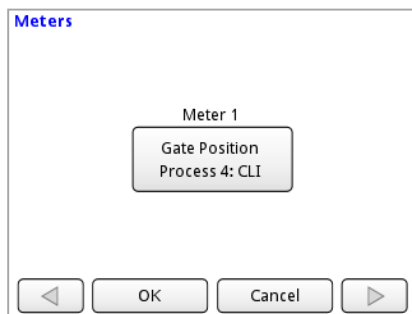

2. If you want to show more than one meter on the screen at a time, press the left or right arrow button to go to the *Meters - Layout* screen, and then simply select the layout you want. Press an arrow button again to return to the *Meters* menu screen.

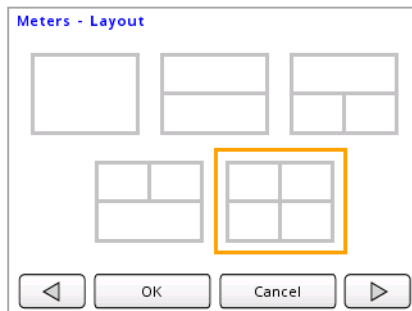

3. Press the button for the meter position you wish to configure. This will display the meter configuration screen. Depending on the selected meter type you will see a slightly different screen.

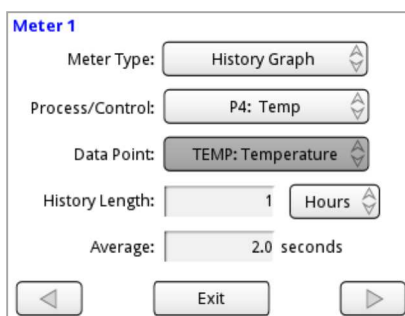
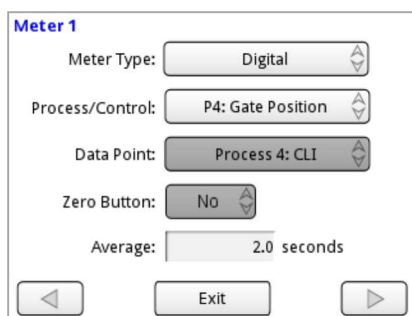

4. Configure the meter:

Meter Type – Choose from **Digital**, **History Graph** or **Off**.

Process/Control – Selects the enabled process you wish to display

Data Point – Selects the type of data you wish to display for the selected process (i.e. A Total/Rate process can either display a counter's total as it increments or the rate at which pulses are received.)

Zero Button – Allows the option of displaying a Zero button on the meter for Total meters and data for analog inputs where the I/O configuration defaults for the process have been overridden.

History Length – (Displayed for the *History Graph* meter type.) Select the length of time to display on the horizontal axis of the meter's history graph. Possible values range from 23 seconds to 24 hours.

Average – Specifies the time period over which sampled signals will be collected for averaging

5. Press **Exit**. This will return you to the Meters menu.
6. Press **OK** to apply your changes or **Cancel** to return to the *Main* menu without applying your changes.

➤ **To configure indicators for a Digital meter**

1. Enter the meter's configuration screen and press an arrow button to navigate to either the *Left Indicator* or *Right Indicator* configuration depending on which one you want to configure. You can turn on one or both indicators and specify thresholds for each. Some example screens are shown below.

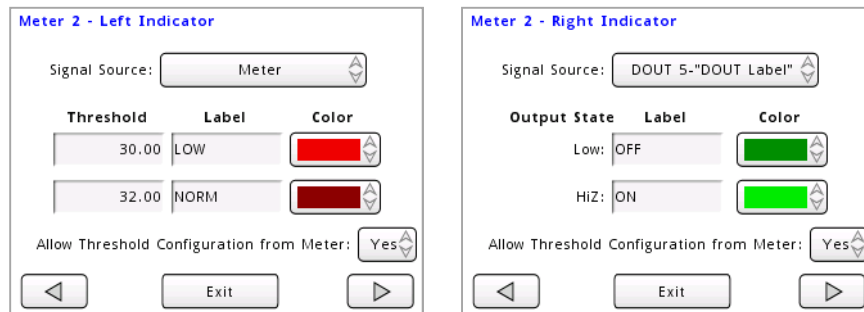

2. Choose the Signal Source, Threshold values (Meter), and indicator labels and colors.

Signal Source – lets you choose the source that will control the indicator's on/off state. Possibilities include the meter value, a digital input, or a digital output. Note, other than the *Meter* source, only I/O configured as digital inputs or outputs that are enabled will be available for selection.

Threshold – (Signal Source: Meter) Two thresholds allow for hysteresis. The indicator label and color will change when the meter value drops below the first threshold value. It will also change when the meter value rises above the second threshold value.

Label – The label text that is displayed on the indicator/button for the given threshold value (meter or digital input) or output state (digital outputs). Up to seven characters are allowed.

Color – The color of the indicator/button for the given threshold value (meter or digital input) or output state (digital outputs).

Allow Threshold Configuration from Meter – The setting, *Yes* or *No*, sets whether or not the given indicator's threshold value can be changed from the *Meter* screen by pressing the indicator image. This can provide a quick way to change the threshold or clear a latched condition without having to navigate through the menus. Setting this option to *No* can prevent unwanted or unintended changes for critical applications.

3. Press **Exit**. This will return you to the *Meters* menu.
4. Press **OK**.

➤ **To configure the plot settings for a History Graph meter**

1. Enter the meter's configuration screen and press an arrow button to navigate to the *Plot Settings* screen.



Color – The line data color (there are nine to choose from)

Plot Type – Choose from: **Thin**, **Thick**, or **Fill**

Y-Axis Max, Y-Axis-Min. – Specifies the maximum and minimum values for the vertical y-axis. You should choose values that will allow your data to be plotted within the graphing area.

2. Press **Exit**. This will return you to the *Meters* menu.
3. Press **OK**.

Example: Assign the Temperature process created earlier to a meter

The following table lists the error messages that may be displayed on a meter when using the RTD temperature sensor.

Table 6-1 RTD Error Messages

RTD Error	Description
CONN	Connection to the RTD temperature sensor is faulty. Check the connections.
START	The SmartVue is starting up and data has not yet been received from the signal conditioning circuitry.
OVER	The temperature measurement is above the measurement range of the sensor.
UNDER	The temperature measurement is below the measurement range of the sensor.

1. Select **Meters** from the *Main* menu.
2. Press the button for a meter position where you want the temperature process data to be displayed. (If desired, use an arrow button to change the number of meters that can be displayed and then go back to the previous *Meters* menu.)

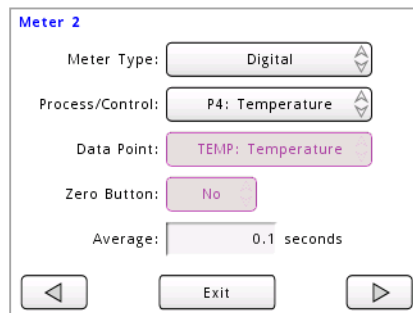

Meter 2

Meter Type: Digital

Process/Control: P4: Temperature

Data Point: TEMP: Temperature

Zero Button: No

Average: 0.1 seconds

Navigation: [Left Arrow] [Exit] [Right Arrow]

3. Use the **Process/Control** spinner to find the name for the temperature process you created earlier.
4. Choose the time period in seconds over which sampling will take place for a running average of the meter.
5. Press **Exit**, **OK**, and then **Exit** again to return to the *Meter* screen to see your new meter.

7.0 Setting Up an Output

You can enable one or more outputs to be controlled by a Process or a Control Process. It is not required that a standard Process be connected to an output, but it is required for a Control Process. Controlling an output with a standard Process is akin to *open-loop* control, that is, there is no feedback.

Assuming you already have a process configured, follow the steps below to setup an output so that its value is varied by the selected process' input.

➤ **To setup an output to use with a Process or Control Process.**

1. Select **MENU > Set Outputs**. This will display the first page for the various outputs that the SmartVue provides. Pressing an arrow button here will display the second page showing the multipurpose I/O points. Those that have been configured as digital outputs can be used.

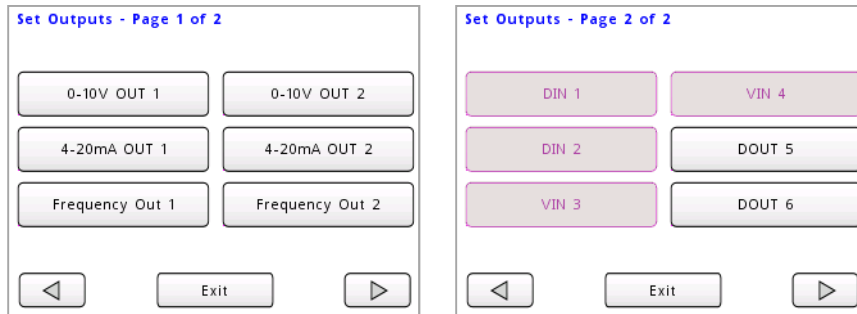

2. Press the button for the output you wish to use. This will display its corresponding configuration screen. The configuration screens for analog signals are similar in appearance and include numerical controls for setting an output scale. The digital version includes controls for setting on/off thresholds and polarity. Both types are shown below.

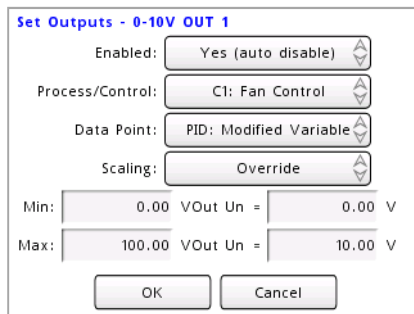

Set Outputs p1 - DOUT 6 - Temp Threshold

Enabled:

Process/Control:

Data Point:

Set Outputs p2 - DOUT 6 - Temp Threshold

Source - P1: Sample Process (TEMP:Temperature)

Mode:

HiZ Threshold:

Low Threshold:

Notes

- Auto disable** – To prevent a potentially unpredictable output to an externally connected device, if the *Enabled* spinner is set to *Yes (auto disable)*, the output will automatically be disabled if the process' scale or the I/O configuration is changed. If it is simply set to *Yes*, the output will not be disabled if the process' scale configuration is changed.

7.1 Using the Current Loop Outputs

The SmartVue's two 4 - 20 mA current loop outputs are each designed to work in one of two modes: *active*, where the SmartVue provides the loop power or *passive*, where the SmartVue must rely on loop power supplied by an external device. To use a current loop output as an active source it must have external excitation from a supply voltage. The Field Supply is conveniently located on the same connector to provide such a source.

For example, to use Current Loop Output 1 in active mode, you must hook up your current loop device as shown in the Figure 7-1 below. The passive mode hookup is shown in Figure 7-2.

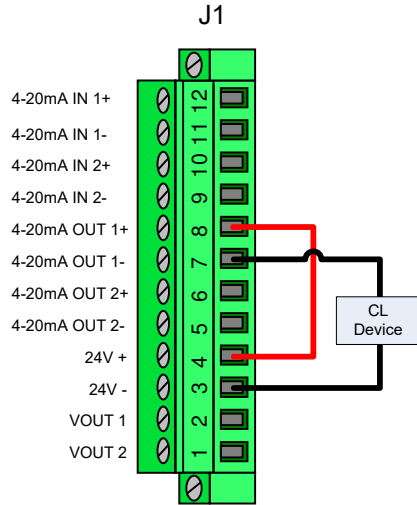

Figure 7-1 J1 wiring to use 4-20mA OUT 1 in active mode

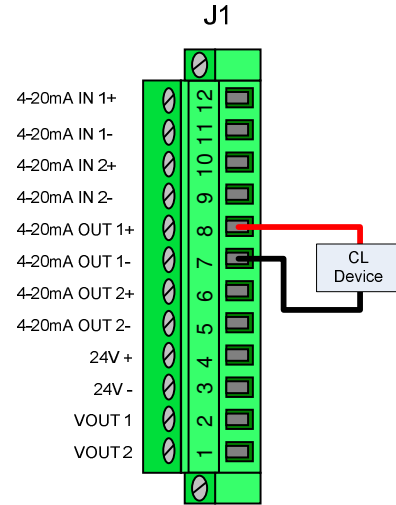

Figure 7-2 J1 wiring to use 4-20mA OUT 1 in passive mode

Notes

- The field supply, voltage outputs, and current loop inputs and outputs are isolated from all other connections.

7.2 Using the Analog Voltage Outputs

The SmartVue provides two analog voltage outputs that operate in the range of 0 to 10 volts with an output impedance of 100 ohms, and a maximum current of 10 mA. The grounding reference is the 24V- terminal of the field supply. Figure 7-3 shows the wiring for connecting a voltage device to VOUT 1.

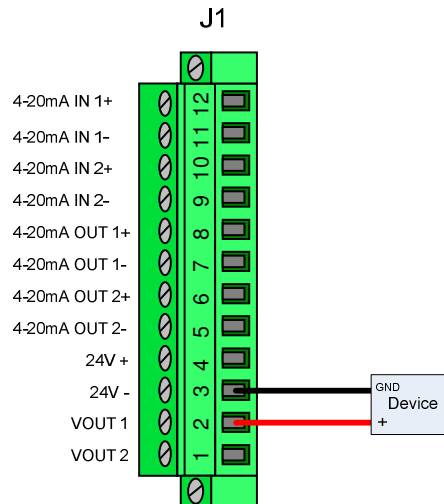

Figure 7-3 Voltage device connected to VOUT 1

7.3 Using the Frequency Outputs

The two frequency outputs each provide a square wave from 0 to 6,250 Hz. Figure 7-4 shows how a device requiring a frequency input would connect to the SmartVue.

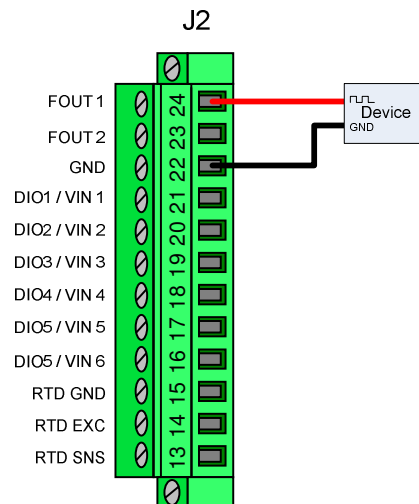

Figure 7-4 Frequency input device connected to FOUT 1

7.4 Using the Digital Outputs

One or more digital outputs can be controlled by a Process so that its logical state is toggled when a specific threshold value is reached. They can thus be used to turn other connected devices or indicators on or off when a certain measured signal condition is met. This function can work in one of three modes, depending on the type of source process that is selected: Threshold, Latching, and Switching. When you want to manually control a digital output you can also set it to a fixed value: on or off.

A digital output can be enabled or disabled to link or unlink it from a process if need be. When it is disabled it will not be controlled by the process it is associated with.

The digital outputs are open collector to ground. When a digital output is turned on, the open collector circuitry sinks to ground so that whatever device you may have connected to it will conduct a current and thus be considered to be turned on. If needed, internal pull-up resistors can be enabled to provide a pull-up of +10 to +30 volts through an internal reference diode. This is accomplished through the *Configure I/O, Multipurpose I/O* setup screen.

7.4.1 Threshold Mode

Figure 7-5 shows the configuration screens for a digital output for which the state depends on an analog input (in this case a current loop input). With the *Mode* configured as *Threshold*, when the HiZ threshold is surpassed, the assigned digital output will go high. Likewise, when the low threshold

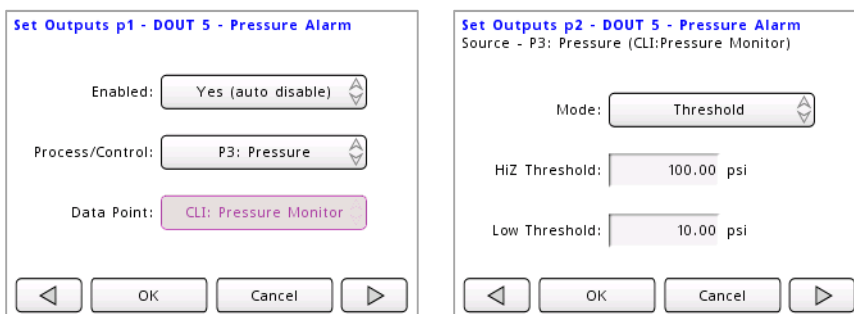

Figure 7-5 Digital output configuration screens

In the example figure above, DIO 5 will turn on as the pressure rises above 100 psi and turn off as the pressure falls below 10 psi.

Hysteresis is possible by specifying both a low and a high threshold value. This is helpful when the signal that controls the digital output crosses the threshold frequently within a short period of time producing a chattering effect. An inverted polarity characteristic is possible by setting the *Low Threshold* value larger than the *HiZ Threshold* value.

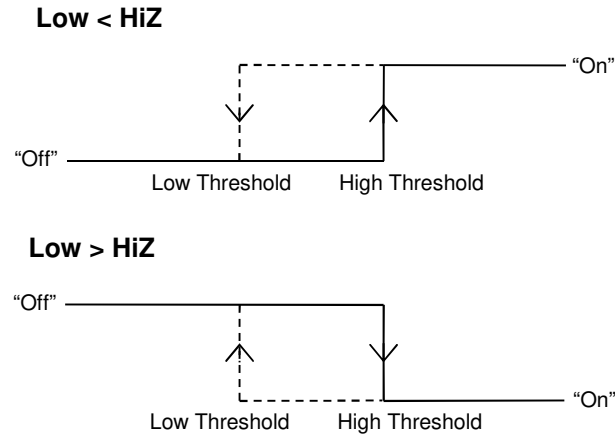

Figure 7-6 Digital output on/off behavior for Threshold mode

Notes:

- For *Normal* polarity, the On threshold value must be larger than the Off Threshold. Likewise, for *Inverted* polarity the Off threshold value must be larger than the On Threshold.

7.4.2 Latching Mode

The *Latching* mode toggles a digital output when a prescribed threshold value is reached but keeps the output in its new state until it is manually reset to its previous state.

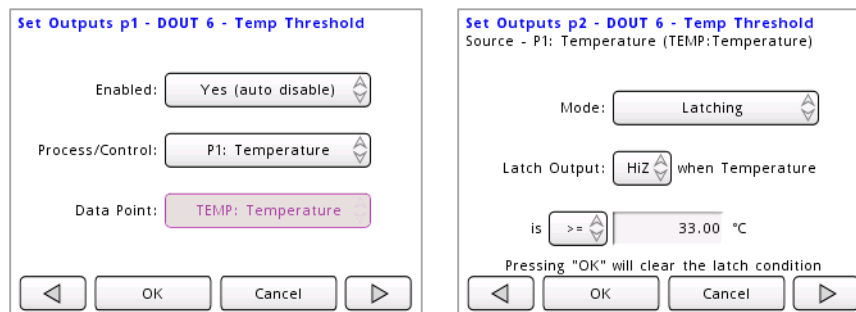

Figure 7-7 Set Outputs screens for latching mode with an analog input source

Two latching conditions are possible: “>=” (greater than or equal to a value), or “<=” (less than or equal to a value). If the latch condition is met, the latch output can be configured to toggle low or to the high impedance state (*HiZ*).

A latch can be cleared by pressing **OK** on the *Set Outputs* configuration screen shown above or on the *Meter Indicator* configuration screen shown below (if configuration from the *Meter* screen is enabled).

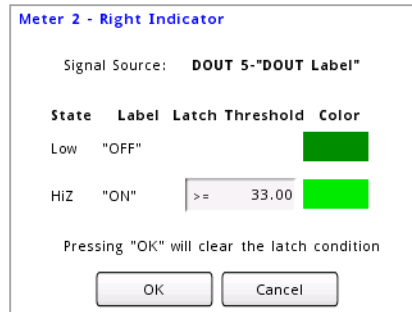

Figure 7-8 Pressing an *enabled* indicator button on the *Meter* screen is a convenient way to clear a latch condition

If the input source is a digital input, the screen will appear slightly differently. Latching can be set to be either HiZ (high impedance) or Low when the digital source is either high or low.

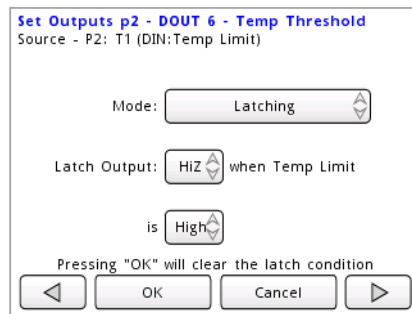

Figure 7-9 Set Outputs screen for latching mode with an digital input source

Figure 7-9 shows that output DOUT 6 will be latched to HiZ when the digital input signal named, “T1” is high.

7.4.3 Switching Mode

The Switching mode toggles a digital output depending on the state of the selected digital input. Polarity of the output can be configured to be either Normal or Inverted (Figure 7-11).

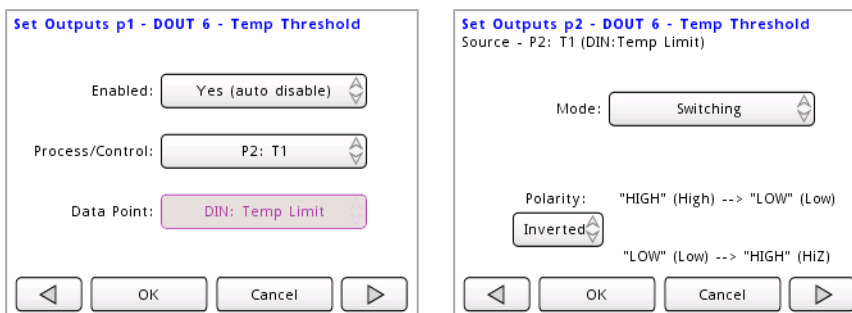

Figure 7-10 Set Outputs screens for switching mode with a digital input source

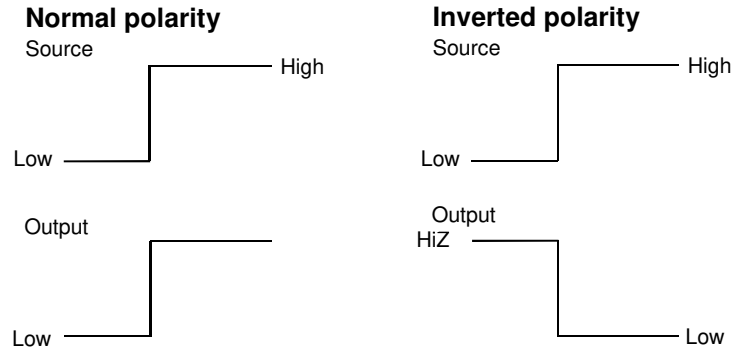

Figure 7-11 Output behavior for normal and inverted polarities

7.4.4 Fixed Outputs

There may be times when you simply want to set an output to a fixed value. A fixed output is one that not associated with a Process and is merely used to generate a desired voltage, current, frequency, or digital output value for use as a source or controlling signal level for some external device.

➤ To set an output to a fixed value

1. Select **MENU > Set Outputs**.
2. Press the button for an output that you wish to set to a fixed value.
3. Turn on the output by selecting **Yes** using the **Enabled** spinner.
4. Set the **Process/Control** spinner to **Fixed**. You will see a screen similar to the either of the ones below depending on the type of output you selected.

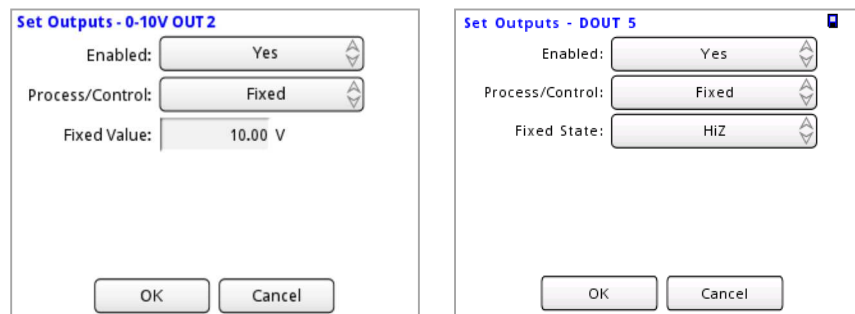

5. Enter a fixed value for the output. For example, if the selected output is 0-10V OUT 2 you can enter a value between 0.0 and 10.0 volts.
6. Press **OK**.

Example: Use a fixed voltage output connected to a potentiometer as the external setpoint control source to a voltage input for a control process.

In this example a potentiometer will be used to set the setpoint for a closed-loop PID control process along with a 4-20mA-based sensor as the feedback component and a multipurpose I/O point configured as a voltage input as the external setpoint.

1. From the *Main Menu*, choose **Configure I/O > Multipurpose I/O > DIO/VIN 1**, and then set the **I/O Type** to **Voltage Input**. Also set an appropriate scale defaults. You can alter this scale later if you choose to override these defaults. I/O configuration is discussed in more detail in Section 3.0.
2. Using a sensor that provides 4-20 mA and an appropriately sized potentiometer, hookup the J1 and J2 connectors as shown in Figure 7-12.

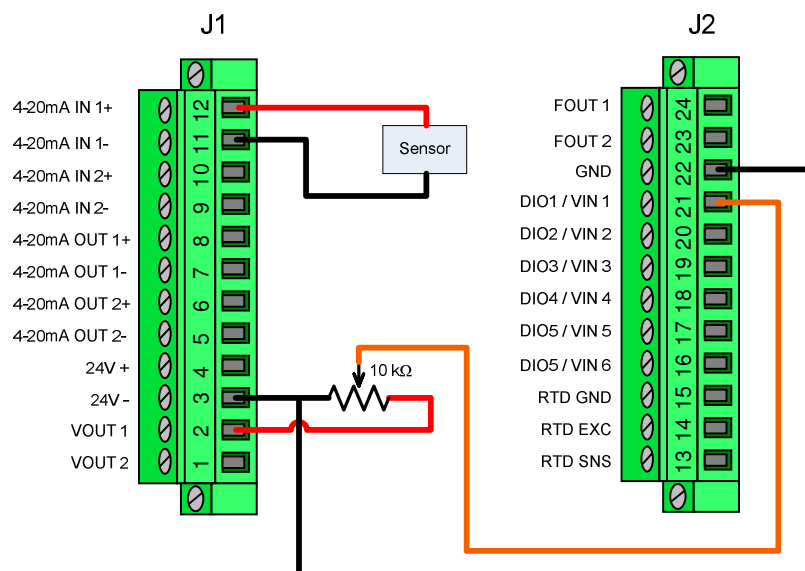
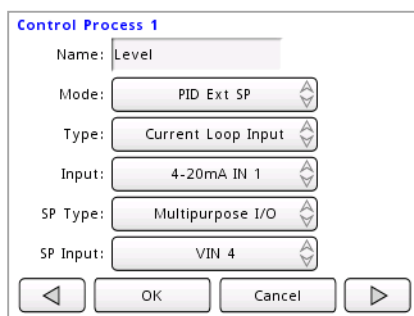

Figure 7-12 J1 and J2 wiring to use 4-20mA OUT 1 as external setpoint control source.

3. Follow the instructions in Section 5.0 to create a control process. You should have a control process setup screen like the following. Note that the input Type, and SP Type and SP Input point will vary with your control process setup.



4. Set scales for the feedback element (sensor) and the setpoint input.

5. Set appropriate PID parameters and press **OK**.
6. From the Main Menu, choose **Set Outputs** and then **0-10V OUT 1** and configure it as a fixed output (refer to Section 7.4) with an appropriate voltage level. You should end up with a screen like the one below, and then press **OK**.

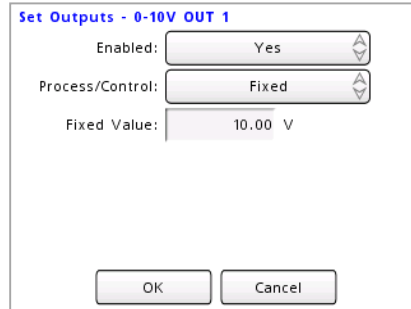

Set Outputs - 0-10V OUT 1

Enabled: Yes

Process/Control: Fixed

Fixed Value: 10.00 V

OK Cancel

7. Setup a meter to display the current loop input for the sensor. You can also setup additional meters to display other values for the control process, such as the error following the instructions in Section 6.0.
8. Save your settings if you want to preserve this setup (**MENU > File System > Save Settings**).

8.0 Run / Stop Modes

Four operational modes control how the SmartVue runs. The *Run / Stop* menu is shown below. The current mode is indicated with a colored icon and is changed by simply pressing the desired mode button.

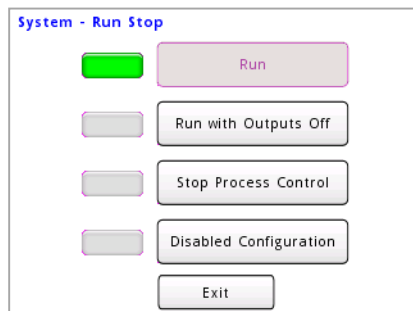

Figure 8-1 The Run / Stop menu

Run is the usual operational mode that the SmartVue uses to run processes and control outputs. The *Meter* screen will display input values and any outputs tied to a process will output signals based on the set configuration.

Run with Outputs Off runs processes but outputs that are tied to any processes are set to off. Voltage outputs are set to zero volts, current loop outputs are set to the minimum value, digital outputs are set to high impedance, and frequency outputs are set to zero hertz. The *Meter* screen will display inputs values as with the *Run* mode.

Stop Process Control disables the processes and no further input values are displayed on the *Meter* screen. Outputs are shut off as with the *Run with Outputs Off* mode described above.



Figure 8-2 The Meter screen the *Stop Process Control* mode is engaged

Disabled Configuration disables the processes as with the *Stop Process Control* mode above, but places the multipurpose I/O into a floating state to prevent the possibility of input signals being inadvertently connected to outputs and vice versa or damage to the I/O points or connected devices until the configuration can be validated for the intended application.

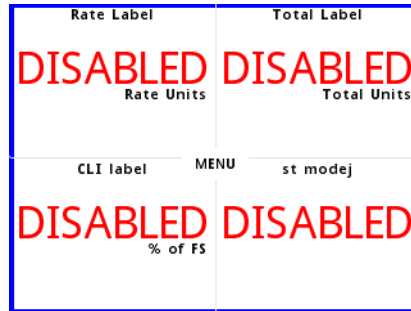

Figure 8-3 The Meter screen the *Disabled Configuration* mode is engaged

9.0 Ethernet Data Communications

The SmartVue is configured as a TCP/IP server and can send process, control process, and I/O data out through the Ethernet port. Up to five concurrent TCP/IP connections can be made with the SmartVue. The screen data can also be sent and displayed or controlled using the *SmartVue Remote* application described in Section 20.0.

The SmartVue can accept ASCII formatted commands in order to request specific sets of data or cause it to stream on a continuous basis.

9.1 Ethernet Settings

In order to properly connect to the SmartVue over TCP/IP appropriate configuration settings are needed. The Ethernet settings consist of the following:

The *IP address* is a unique number that identifies a SmartVue or any other TCP/IP device on a network, so when requests for information are sent to it, it knows to respond. No other TCP/IP devices on the network should have this address.

The *subnet mask*, together with the IP address defines the network that the SmartVue belongs to and which IP addresses can be reached within it.

Each IP address is divided into two parts: the shared network part and the unique host part. When sending data to a device with a different network part, it must be sent through a router to reach its final destination (i.e. to a different network). If they're the same, no router is needed. The host part sets how many unique IP address are allowed on the network. So with a subnet mask of 255.255.255.0 the first three parts of the IP address will form the fixed network number, while the last part of the IP address will allow for 256 (0 to 255) different possibilities.

The *gateway* IP address is the address of the device (such as a router) that serves as the interface between one network and another.

The port number distinguishes command requests from any other type of request that the SmartVue may receive. Responses will thus only be generated and returned if a command is sent to the SmartVue using this assigned port number. Port numbers should be in the *registered* port range of 1024 to 49151.

➤ To configure the SmartVue's Ethernet settings

1. Select **MENU > Communications > Ethernet Settings**. The **Ethernet Settings** screen shown below will be displayed.
2. Enable the Ethernet port using the **Enabled/Disabled** control at the top of the screen. If the unit is connected to a network, the yellow LED will turn on and the green LED will flash in proportion to the amount of network traffic. When the control is set to "Disabled" the Ethernet port is disabled.

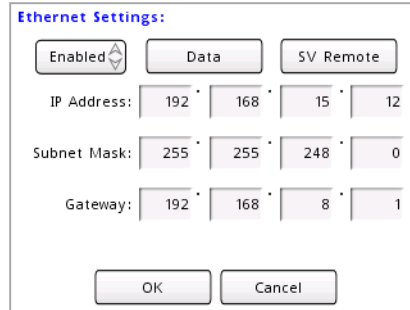

Figure 9-1 The Ethernet Settings screen

- Enter appropriate TCP/IP settings for your network.

IP Address This should be a unique IP address for the SmartVue. No other TCP/IP devices on the network should have this address.

Subnet Mask The default of 255.255.255.0 should suffice in most instances.

Gateway The IP address for the network node (router) that connects your network to an outside network. Typically it shares the first three values of the IP address and uses 1 for the last value.

- Press **OK**.

9.2 Streaming Ethernet Data

The SmartVue can stream process data, IO data, and J1939 SPN and DTC data via the TCP/IP port.

Using the *Auto Send* feature, you can specify that certain data automatically begin streaming when the SmartVue is started without the need to first send a command to request it. A new telnet session formed with the Auto Send feature turned on will also immediately begin to display data.

Note: *Auto Send* settings and data are only updated when an active connection is enabled and started.

➤ To configure the SmartVue to stream process data via TCP/IP

- On the *Ethernet Settings* screen, press the **Data** button. This will display the configuration screen for controlling how and what data will be streamed.
- Set **Data Streaming** to **On**.

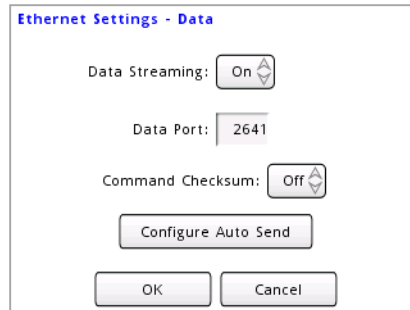

Figure 9-2 Ethernet Settings - Data screen

3. Enter the data port number. The software you use to send commands to the SmartVue must use this port. The default port number is 2641.
4. The **Command Checksum** setting is set to **Off** by default. The *Off* setting will accommodate testing and allow you to manually send commands to the SmartVue without having to include, and thus calculate, the checksum. With the checksum turned on, commands will require that the correctly computed checksum value be included; without it an error response will be generated.
5. Optionally, if you wish to select which sets of data will be sent automatically when the SmartVue is powered up, press **Configure Auto Send**. This will display the *Auto Send* configuration screen.

Set **Auto Send** to **On** to activate this feature.

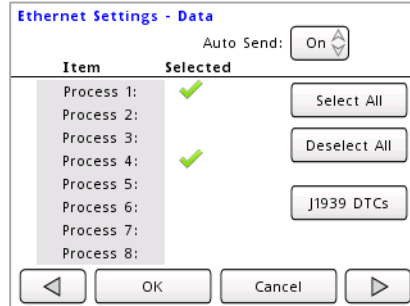
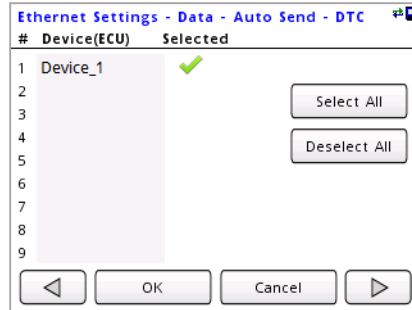

Figure 9-3 Ethernet Settings – Configure Auto Send screen

Select items from the *Item* column for the data sets you wish to receive. Press **Select All** to check all of the boxes at once or **Deselect All** to uncheck all of them. (Note, remember to save the SmartVue's settings if you want your selection to persist after it's been powered off.)

Also, optionally, if the J1939 communications stack is enabled then active Diagnostic Troubleshoot Codes (DTCs) can also be streamed for devices (ECUs) that have been added using the J1939 Diagnostics Configuration screen. Press the **J1939 DTCs** button to display them and then select the ones you want to receive streamed data for by pressing the device name. If the list is blank, no ECUs have yet been selected through the J1939 Diagnostics Configuration. (Refer to Section 10.7 for more information regarding DTCs.)



Press **OK** to accept your changes and then **OK** again to return to the Ethernet Settings - Data screen.

6. Press **OK**. You should now be back on the Ethernet Settings screen.
7. Press **OK** to apply your changes.

If you already had an open telnet session to the SmartVue you were configuring Ethernet settings for (including Auto Send data), you must close it and start a new session to see the changes.

9.3 Commands

Commands can be sent to the SmartVue using an application capable of sending and receiving data via TCP/IP. (An example application is discussed in a later section.) The SmartVue accepts commands in ASCII format and may be either uppercase or lowercase. Each command begins with the letter “C” followed by a three digit value indicating the type of command, and is terminated with a 16-bit checksum, as well as carriage return and line feed characters.

For testing purposes the command checksum can be disabled as mentioned in the previous section. For example, if you wanted to conveniently obtain data or to test a connection via a Telnet session without having to calculate the checksum you can disable the checksum requirement.

To help with the interpretation of command syntax, the following conventions are used.

- Bold** is used for commands and options.
- Italic* is used to show generic options that should be replaced with user-supplied values.
- [] surround optional elements. (The brackets themselves are not entered.)
- CS indicates the 16-bit, hexadecimal checksum value in the range 0000 to FFFF.
- <CRLF> represents the carriage return and line feed characters.

Note that all connections to a SmartVue share the same interface, so sending a command with one connection will affect all other connections to it.

The 16-bit checksum is generated by adding up all of the bytes in a command (or a response) up to and including the comma before the checksum field while discarding any overflow bits. Likewise, when data is received from the SmartVue, the received checksum can be verified the same way to ensure data integrity.

Analog data is given in scientific notation with a decimal part and an exponential part. For example, a number like 538.2 will be displayed as 5.382000e+02, which means 5.382000×10^2 . A value such as 0.4193 would be given as 4.193000e-01.

9.3.1 Stream Data Start (000)

C000[d_1, d_2, \dots, d_n][CS]**<CRLF>**

The *Stream Data Start* command enables the transmission of the SmartVue's data packet once per second. Options d_1 to d_n designate which data sets are to be returned. The order in which the data set options are specified will determine the order in which they are returned.

Note that the data stream will stop if the *Poll Data* command is executed.

The data set options are given in the table below.

Options

P1	Process 1
P2	Process 2
P3	Process 3
P4	Process 4
C1	Control 1
C2	Control 2
IO	Input/Output
JD	J1939 SPN Data
D_n	J1939 DTC, where n can be 1 to 16

Examples

Obtain the data set for Process 2 followed by Process 1.

C000,P2,P1[CS]**<CRLF>**

If the command is successful an *OK* response will be received and then the periodic data transmission will begin starting with the characters, *D000*.

OK,R000[CS]**<CRLF>**

D000,SV009S000000,2011-06-30,15:51:00,P2,...data...,LENGTH[CS]**<CRLF>**

D000,SV009S000000,2011-06-30,15:51:01,P2,...data...,LENGTH[CS]**<CRLF>**

...

Whenever a data set is received a length field is included and can be used in addition to the checksum to verify the integrity of the data. The data length is calculated by adding the number of characters received starting with the serial number up to and including the comma before the *LENGTH* field.

Obtain all data sets.

C000,P1,P2,P3,P4,C1,C2,IO,JD[CS]**<CRLF>**

Get the data packet header containing just the date, time and SmartVue serial number.

C000[,CS]<CRLF>

9.3.2 Stream Data Stop (001)

C001[,CS]<CRLF>

The *Stream Data Stop* command stops the continuous streaming of data packets. Note the stream will also stop if the *Poll Data* command is sent.

To stop the data stream use,

C001[,CS]<CRLF>

If the command is successful, the following response will be returned:

OK,R001,01D5<CRLF>

Note that 01D5 is the calculated checksum for this response.

9.3.3 Poll Data (002)

C002[,d₁,d₂,...d_n][,CS]<CRLF>

The *Poll Data* command works the same way as the *Stream Data Start* command but only one data packet is returned and it is included in the command response packet.

Examples

Obtain one complete data set.

C002,P1,P2,P3,P4,C1,C2,IO[,CS]<CRLF>

If the command is successful an *OK* response will be transmitted with the data appended.

OK,R002,SV009000000,2011-06-30,23:59:59,P1...data...[,CS]<CRLF>

Refer to tables in section 9.4 *Data Output*, for a summary of the various data fields.

9.3.4 Error Responses

If a command fails an error response beginning with the characters “ER” will be returned followed by an error code. Error responses have the form,

ER,code[,command],CS<CRLF>

The following error codes may be encountered.

BUF	indicates a command buffer overflow.
CMD	means that an invalid command was received.
CSM	indicates a checksum error. In this case the command was likely corrupted in transmission and should be resent.
DUP	indicates a duplicate parameter was received. The sent command will also be returned with this error.
PAR	means an invalid parameter was received. The sent command will also be returned with this error.

9.3.5 Testing with Telnet

While a Telnet client is included with Microsoft Windows® it is not recommended for communicating with the SmartVue. A suggested program is *PuTTY*, which is freely available at <http://www.chiark.greenend.org.uk/~sgtatham/putty/>. It can be installed with or without an installer. A 64-bit version is also available at <https://splunk.net:444/w/PuTTY64bit>.

➤ To send commands to the SmartVue using PuTTY

1. Connect the SmartVue to your network and configure its TCP/IP settings as described in the previous procedure.
2. On the SmartVue, press **MENU > Communications > Ethernet Settings** and set the **Checksum** to **Off**.
3. Run the **PuTTY** program on your PC.
4. Enter the **IP address**, **Port** number and a **Connection type** of **Telnet** as shown in the program window below. You can also give the session a name (i.e. “SmartVue”) and save it for easy retrieval later.

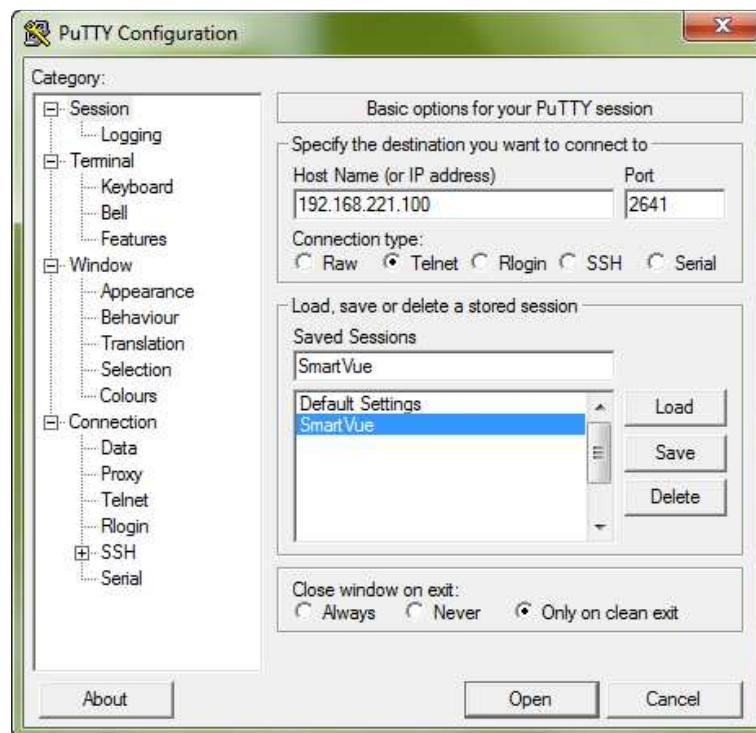

5. Select your newly saved session and then click **Open** or simply double-click its name to connect and begin the Telnet session.
6. If data is not already streaming, you could enter a command like, C000,P1 to turn on streaming and continuously return data for Process 1. New commands can still be entered while data is streaming.
7. When you're done testing, click the icon in the upper right to display the program menu and select **Close**.

9.4 Data Output

The data packet consists of a header plus any user selected data sets, P_n , C_n , IO, JD and/or D_n followed by the data length in bytes. The following tables summarize the contents of the data packet components.

Data Header		
Field Label	Field Name	Data
SN	Serial Number	String (12 Characters)
D	Date (YYYY-MM-DD)	String (10 Characters)
T	Time (24 Hour Format) (HH:MM:SS)	String (8 Characters)

Process Data Section				
Process Type*/ Input Type	Field Label	Field Name	Data	Units
	DT	Data Type (P = Process)	P1,P2,...P8	
0/NA	PT	Process Type (0 = Off)	0	
1/1,2,3, or 5	PT	Process Type (1 = Standard)	1	
	IT	Input Type (1=CLI, 2=VI, 3=DI, 5=TEMP)	Integer	
	IC	Input Channel (1-6)	Integer	
	SPDATA1	Scaled Process Data	Float	User specified
1/6	PT	Process Type (1 = Standard)	1	
	IT	Input Type (6=Total/Rate)	6	
	IC	Input Channel (1-7)	Integer	
	SPDATA1	Scaled Process Data 1 (Rate)	Float	User specified
	SPDATA2	Scaled Process Data 2 (Total)	Float	User specified
1/7	PT	Process Type (1 = Standard)	1	
	IT	Input Type (7=SPN Analog)	7	
	IC	Input Channel (1-32)	Integer	
	SPDATA1	Scaled SPN Data	Float	User specified
1/8	PT	Process Type (1 = Standard)	1	
	IT	Input Type (8=SPN State)	8	
	IC	Input Channel (1-32)	Integer	
	SPDATA1	Raw State Data in decimal	Integer	none

* The Process Type (PT) field can also contain an error bit at position 0x10 that is OR'd with the process type value when a process has an error (i.e. if the process is invalid, or the process has an error, such as an RTD connection error or if a J1939 SPN times out, etc.) Thus, if the expected value is 1 for the Process Type, but the process is experiencing an error situation, the PT field will actually have the decimal value 17 (0x01 OR'd with 0x10 = 0x11 or 17 decimal).

Control Data Section				
Control Type	Field Label	Field Name	Data	Units
	DT	Data Type (C = Control)	C1 or C2	
0	CT	Control Type (0 = Off)	0	
1	CT	Control Type (1 = PID)	1	
	FBIT	Feedback Input Type (1,2,5 or 6)	Integer	
	FBIC	Feedback Input Channel (1-7)	Integer	
	MV	Modified Variable	Float	User specified
	FB	Feedback	Float	User specified
	ERR	Error	Float	User specified
	SP	Setpoint	Float	User specified
	RES	Reserved	Float	
	ITERM	I Term	Float	User specified
	DTERM	D Term	Float	User specified
2	CT	Control Type (2 = PID w/External SP)	2	
	FBIT	Feedback Input Type (1,2,5 or 6)	Integer	
	FBIC	Feedback Input Channel (1-6)	Integer	
	SPIT	Setpoint Input Type (1,2,5 or 6)	Integer	
	SPIC	Setpoint Input Channel (1-6)	Integer	
	MV	Modified Variable	Float	User specified
	FB	Feedback	Float	User specified
	ERR	Error	Float	User specified
	SP	Setpoint	Float	User specified
	RES	Reserved	Float	
	ITERM	I Term	Float	User specified
	DTERM	D Term	Float	User specified

Input/Output Data Section			
Field Label	Field Name	Data	Units
DT	Data Type (IO = Input/Output)	IO	
MDIM	Monitor Data Input Mask	0-3FFFFFF (ASCII)	
MDOM	Monitor Data Output Mask	0-FFF (ASCII)	
TEMPSS	Temperature Sensor Status	Integer	
TEMP	Temperature	Float	°C
TACH1	Tachometer Rate 1	Integer	Hz
TACH2	Tachometer Rate 2	Integer	Hz
CTR1	Counter Rate 1	Integer	Hz
CTR2	Counter Rate 2	Integer	Hz
CTR3	Counter Rate 3	Integer	Hz
QUAD1	Quadrature Rate 1	Integer	Hz
QUAD2	Quadrature Rate 2	Integer	Hz
CLI1	Current Loop In 1	Float	mA
CLI2	Current Loop In 2	Float	mA
VI1	Voltage In 1	Float	V
VI2	Voltage In 2	Float	V
VI3	Voltage In 3	Float	V
VI4	Voltage In 4	Float	V
VI5	Voltage In 5	Float	V
VI6	Voltage In 6	Float	V
DI1	Digital In 1	Integer	
DI2	Digital In 2	Integer	
DI3	Digital In 3	Integer	
DI4	Digital In 4	Integer	
DI5	Digital In 5	Integer	
DI6	Digital In 6	Integer	
CLO1	Current Loop Out 1	Float	mA
CLO2	Current Loop Out 2	Float	mA
VO1	Voltage Out 1	Float	V
VO2	Voltage Out 2	Float	V
FO1	Frequency Out 1	Float	Hz
FO2	Frequency Out 2	Float	Hz
DO1	Digital Out 1	Integer	
DO2	Digital Out 2	Integer	
DO3	Digital Out 3	Integer	
DO4	Digital Out 4	Integer	
DO5	Digital Out 5	Integer	
DO6	Digital Out 6	Integer	
STEMP	Scaled Temperature	Float	User specified
STACH1	Scaled Tachometer Rate 1	Float	User specified
STACH2	Scaled Tachometer Rate 2	Float	User specified
SCTR1	Scaled Counter Rate 1	Float	User specified
SCTR2	Scaled Counter Rate 2	Float	User specified
SCTR3	Scaled Counter Rate 3	Float	User specified
SQUAD1	Scaled Quadrature Rate 1	Float	User specified
SQUAD2	Scaled Quadrature Rate 2	Float	User specified
SCLI1	Scaled Current Loop In 1	Float	User specified
SCLI2	Scaled Current Loop In 2	Float	User specified
SVI1	Scaled Voltage In 1	Float	User specified
SVI2	Scaled Voltage In 2	Float	User specified
SVI3	Scaled Voltage In 3	Float	User specified

Input/Output Data Section			
Field Label	Field Name	Data	Units
SVI4	Scaled Voltage In 4	Float	User specified
SVI5	Scaled Voltage In 5	Float	User specified
SVI6	Scaled Voltage In 6	Float	User specified
SCLO1	Scaled Current Loop Out 1	Float	User specified
SCLO2	Scaled Current Loop Out 2	Float	User specified
SVO1	Scaled Voltage Out 1	Float	User specified
SVO2	Scaled Voltage Out 2	Float	User specified
SFO1	Scaled Frequency Out 1	Float	User specified
SFO2	Scaled Frequency Out 2	Float	User specified

Input Channel Table								
Input Type	Channel#	1	2	3	4	5	6	7
	Input Type#							
Current Loop Input	1	4-20mA IN 1	4-20mA IN 2					
Voltage Input	2	VIN 1	VIN 2	VIN 3	VIN 4	VIN 5	VIN 6	
Digital Input	3	DIO 1	DIO 2	DIO 3	DIO 4	DIO 5	DIO 6	
Reserved	4							
Temperature Input	5	RTD						
Total/Rate Input	6	TACH IN 1	TACH IN 2	CTR1	CTR2	CTR3	QENC1	QENC2

Temperature Sensor Status (TEMPSS)	Description
0	No Error
1	RTD Connection Error
2	Reading Under
3	Reading Over

J1939 SPN Data			
Field Label	Field Name	Data	Units
DT	Data Type (JD = J1939 SPN Data)	JD	
NUM	Number of SPNs	Integer	
SPN1	SPN Data	Float if Analog, Integer if State	User Specified
...	SPN Data	Float if Analog, Integer if State	User Specified
SPN_n	SPN Data	Float if Analog, Integer if State	User Specified

Note: Each SPN data field may also be three zeros (000) if J1939 is disabled or a data error or two zeros (00) if the SPN is disabled.

J1939 DTC Data			
Field Label	Field Name	Data	Units
DT	Data Type (D = J1939 DTC Data)	D1...D16	
ECU	ECU Address	Integer	
NCODES	Number of Codes	Integer	
DTC1	SPN Number	Integer	
FMI1	SPN Data	Integer	
OC1	Occurrence Count	Integer	
...			
DTCn	SPN Number	Integer	
FMIn	SPN Data	Integer	
OCn	Occurrence Count	Integer	

Note: The ECU address data field may also be three zeros (000) if J1939 is disabled or a data error or two zeros (00) if the DTC slot is disabled.

Example: A simple data packet including a single Temperature process, P4

D000, SV009S001026, 2012-07-24, 08:58:42, P4, 1, 5, 1, 2.317000e+01, 0037, 0D46

D000	Streamed data response
SV009S001026	SmartVue serial number
2012-07-24,08:58:42	Date/timestamp
P4	Beginning of Process 4 data set
1	Process type: Standard
5	Input type: Temperature
1	Input channel: 1
2.317000e+01	23.17 °C
0037	Length in bytes (hexadecimal)
0D46	Checksum (hexadecimal)

10.0 SAE J1939 Communications

The Society of Automotive Engineers (SAE) developed the J1939 bus standard to allow equipment used in industry to communicate with one another and report on the states of various systems. J1939 thus forms the basis for the popular Controller Area Network (CAN) protocol, which communicates on a simple dual-wire, serial interface and facilitates the exchange of data between electronic control units (ECUs) in automotive, aerospace, agricultural, and factory automation systems. A multitude of parameters can be monitored on a CANbus including such things as torque control, engine speed, engine oil temperature, throttle position, and much more.

The following diagram shows how the SmartVue can be connected to a CANbus.

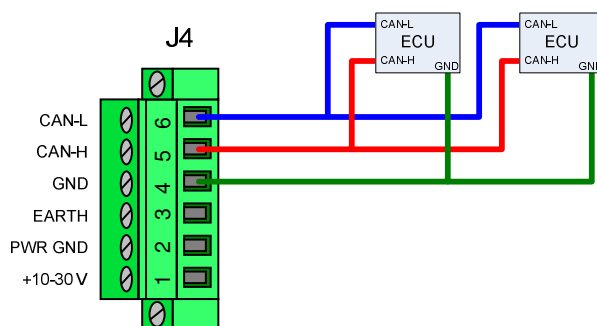

Messages transmitted on the J1939 network include values that identify data being requested or sent by ECUs. Among other things, each message contains a Parameter Group Number (PGN), source address, and priority. If the message is intended to be peer-to-peer it will also include a target address that has made the request for the information.

Parameters that have common characteristics are grouped together into a Program Group (PG) identified by the PGN. The J1939 standard defines the specific data parameters that are associated with each PGN and how they are arranged. Each parameter is, in turn, identified by a Suspect Parameter Number (SPN). For example, PGN 65269 describes a set of data values that provide information about the ambient temperature and pressure conditions.

PGN 65269 Ambient Conditions

SPN	Parameter Name
108	Barometric Pressure
170	Cab Interior Temperature
171	Ambient Air Temperature
172	Engine Air Inlet Temperature
79	Road Surface Temperature

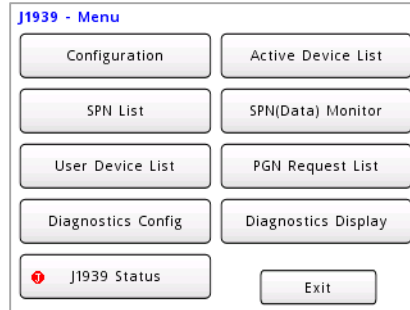
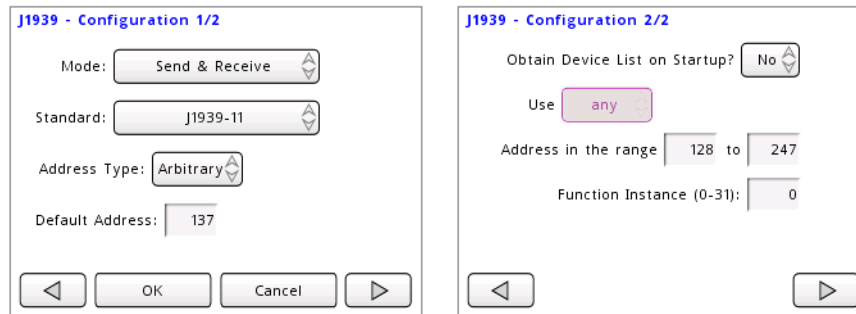
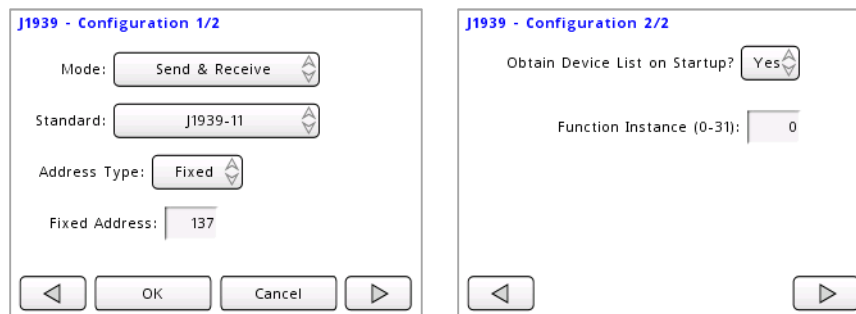

Figure 10-1 The J1939 menu

10.1 Configuration

Press **Configuration** on the J1939 menu to access the setup screens for J1939 communications.

Top level configuration of the J1939 protocol consists of setting the mode, standard and type of addressing that will be used for communications.

Figure 10-2 J1939 Configuration with an address type of *Arbitrary*Figure 10-3 J1939 Configuration with an address type of *Fixed*

Mode

- **Monitor Only** This mode option permits the monitoring of active PGN data on the J1939 bus. The SmartVue will not send any requests for additional PGNs. (The CANbus interface will be deactivated in this mode.)
- **Send & Receive** With this setting the SmartVue will be identified on the network as an ECU with its own address. In addition to being able to monitor SPN data,

the SmartVue will be allowed to make requests for new PGNs that aren't already active on the J1939 bus. Note, that this will add additional traffic to the J1939 network, which should be avoided unless necessary to get SPN data that is not already available.

- **Disabled** With this option setting, the J1939 communications stack will not be initiated and SPN or DTC monitoring on the bus will not be possible.

Standard

The communications standard defines the set of rules for how information is to be transmitted on a communications bus including the type of data that is to be expected and how it should be arranged and deciphered.

- **J1939-11** This standard is used for control and communications on commercial and heavy duty vehicles as well as other equipment, to provide information from engine, brake, and transmission controllers, among others.
- **ISO11783 (ISOBUS)** Based on the J1939 communications standard, the ISOBUS standard defines a more specific set of data for control and communications on equipment and machinery used in the agricultural and forestry industries. Only *Arbitrary* addressing is used if this standard is selected.

The following options can only be set if the J1939 operating mode is set to *Send & Receive*. If you wish to obtain particular SPN data that is not actively on the bus then the SmartVue must claim and address and identify itself on the bus to make the request for a PGN that includes the desired data.

Address Type

- **Arbitrary** Should a conflict occur when a claim is made for the *Default Address* (see below) an attempt will be made to claim another.
- **Fixed (J1939-11 only)** A SmartVue with a fixed address will not attempt to make a claim for a new address should a conflict with another ECU occur on the bus, but will instead wait for it to become available.

Default/Fixed Address This is the address by which the SmartVue will be identified on the J1939 network. It may be a value from the general address pool of 128 to 247 inclusive. The default address is 137, but may be changed to any value within the given range.

Obtain Device List on Startup? If *Yes*, the SmartVue will check the bus for ECUs that are actively transmitting messages when the SmartVue is powered up and list them on the *Active Device List* screen. This adds a modicum of traffic to the J1939 bus when the SmartVue is started.

Use available/any (address) If set to *available*, the SmartVue will use only use an address that is not currently in use on the J1939 bus. If *any* is selected (*Arbitrary* address type only), then a claim for any address within the specified range will be will be made. The overall range is 128 to 247, but may be limited if desired.

Function The SmartVue will be identified on the bus as a *System Monitor* (function 33) by default. A function with a lower number will have a high priority when it comes to message handling on the network.

Function Instance This value allows you to differentiate the SmartVue from any other device on the network that may also have the same function, but different instance value.

10.2 Active Device List

What information is available on the bus (or can be requested to be on the bus) depends on which devices (ECUs) are connected and active on the network.

To see the list of active devices on the network, select **MENU > Communications > J1939 Menu > Active Device List**.

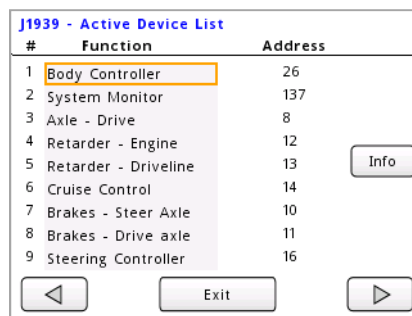

#	Function	Address	
1	Body Controller	26	
2	System Monitor	137	
3	Axle - Drive	8	
4	Retarder - Engine	12	
5	Retarder - Driveline	13	Info
6	Cruise Control	14	
7	Brakes - Steer Axle	10	
8	Brakes - Drive axle	11	
9	Steering Controller	16	

Figure 10-4 The J1939 Active Device List

The Active Device List shows the list of devices that are communicating on the CAN bus. Each device sends a name describing its function along with its address.

To get more information about a specific device, select its function name and then press the **Info** button.

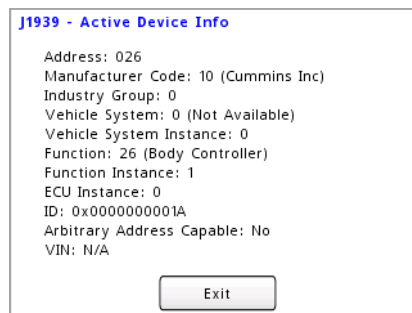

Address: 026
Manufacturer Code: 10 (Cummins Inc)
Industry Group: 0
Vehicle System: 0 (Not Available)
Vehicle System Instance: 0
Function: 26 (Body Controller)
Function Instance: 1
ECU Instance: 0
ID: 0x000000001A
Arbitrary Address Capable: No
VIN: N/A

Figure 10-5 Active Device Info screen

10.3 SPN List

The SPN list shows the list of SPNs that have been selected for monitoring either on the *SPN Data Monitor* screen or on the SmartVue's Meter screen. Up to 32 SPNs may be added to the list.

10.3.1 Add an SPN to the List

➤ **To add to the SPN List from the list of active SPNs**

1. Select **SPN List** from the J1939 Menu.
2. Choose a row that has nothing entered in it by selecting the area in the **Label** column. (Notice that the selectable areas on this screen have a light grey background color).
3. Press the **Add** button.

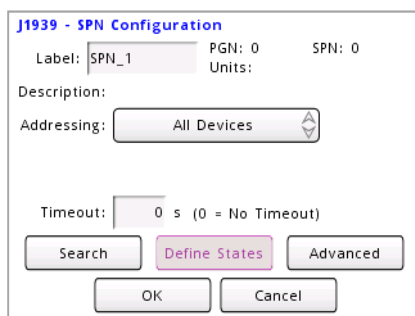

4. Press the **Search** button to search for, and select, the desired SPN.

You can conveniently select from a list of active PGNs or SPNs. In the example figures below, the SPN button was pressed and then SPN 110 was selected.

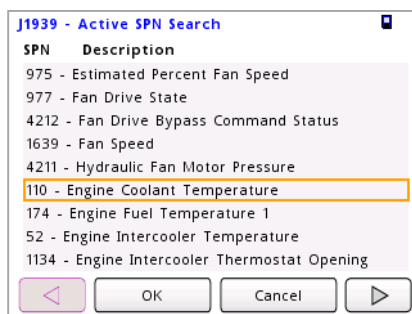
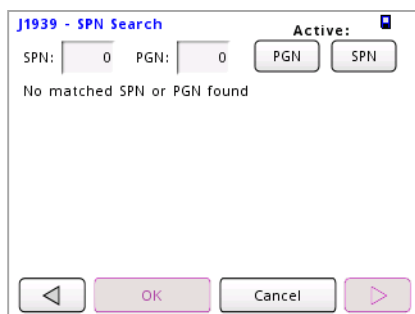

Press **OK** to return to the *SPN Search* screen. You'll notice detailed information related to the selected SPN is now displayed.

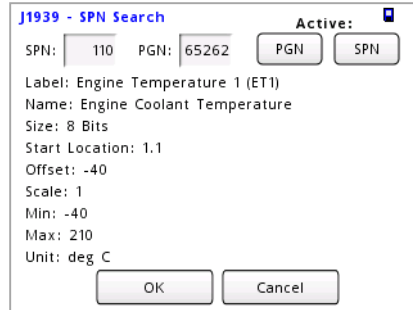

J1939 - SPN Search Active:

SPN: 110 PGN: 65262 PGN SPN

Label: Engine Temperature 1 (ET1)
 Name: Engine Coolant Temperature
 Size: 8 Bits
 Start Location: 1.1
 Offset: -40
 Scale: 1
 Min: -40
 Max: 210
 Unit: deg C

OK Cancel

5. Press **OK** to return to the *SPN Configuration* screen.

6. Select **All Devices** for the **Addressing** mode.

If you know the address of the device (ECU) that is supplying the data for the selected SPN you could specify an addressing mode of *Fixed (By Address)* and then enter the address. Likewise, if you have a user defined device you can select an addressing mode of *Arbitrary (By Name)* and then press the Device List button to select it.

7. Enter an appropriate label in the **Label** box to that will descriptively identify the parameter on the *SPN (Data) Monitor* screen.

8. Press **OK**. The SPN List now shows the newly added SPN.

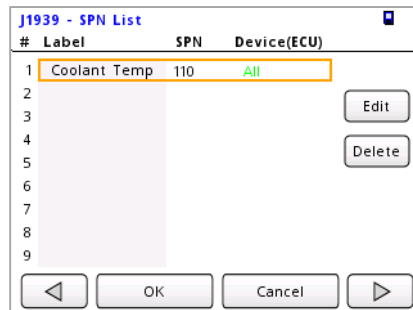

J1939 - SPN List Active:

#	Label	SPN	Device(ECU)
1	Coolant Temp	110	All
2			
3			
4			
5			
6			
7			
8			
9			

Edit
Delete

◀ OK Cancel ▶

You can edit an existing SPN by selecting its label and pressing the **Edit** button.

To delete an SPN from the list, select its label and press **Delete**.

10.4 SPN (Data) Monitor

The *SPN (Data) Monitor* screen is used to monitor any SPN data selected using the SPN List. Up to 16 separate SPNs may be monitored.

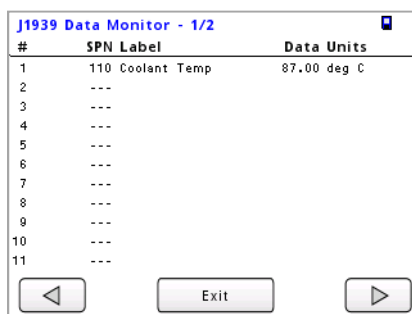

Figure 10-6 The SPN (Data) Monitor screen



Rapid SPN Changes

If an SPN data value changes very quickly, events that occur within a half-second window could be missed because of their short duration and the inherent nature of the discrete sampling.

10.4.1 Display SPN data on the Meter Screen

You can also display SPN data values on the SmartVue's Meter screen in the same way that I/O data is displayed. When setting up a process, simply select a process type of *J1939 SPN*, the Input spinner control will list the active SPNs that are included on the SPN List. The meter can display analog SPN value as either a digital or history graph, as in the example figures below.

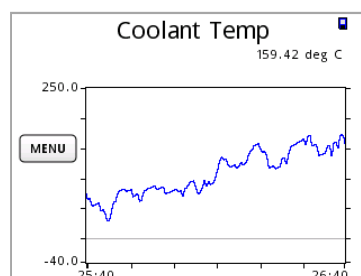
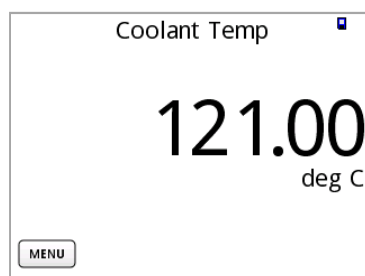
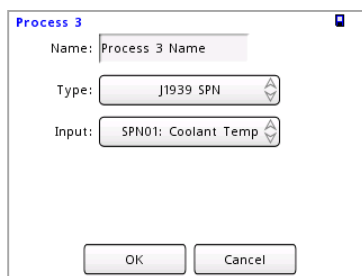

10.5 User Device List

Any device from which you wish to request one or more PGNs (to thus get subsequent SPN data) will be added to the *User Device List*.

➤ To add a device to the User Device List

1. Select **User Device List** from the *J1939 Menu*.
2. Choose a row that has nothing entered in it by selecting the area in the *Device Name* column. (Notice that the selectable areas on this screen have a light grey background color).
3. Press the **Add** button.
4. Enter an appropriate name for the device. Configure the various fields.

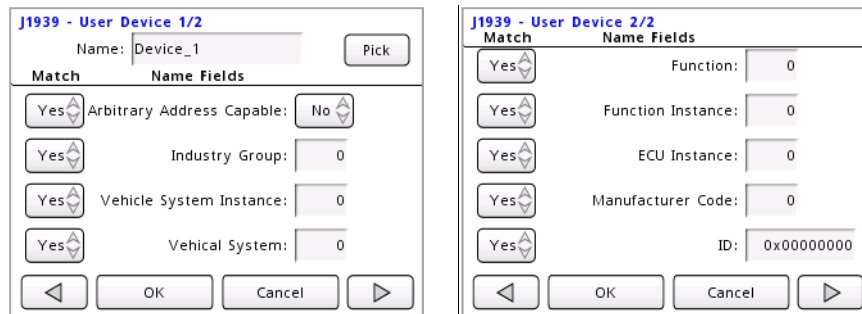

5. Press **OK**. The newly added device will appear on the list.



10.6 PGN Request List

The PGN Request List is used to select PGNs that for which related SPN data is desired, but is not already being transmitted on the bus.

➤ **To select additional PGNs to be transmitted on the bus by any (or all) available ECUs**

1. Select **PGN Request List** from the *J1939 Menu*.
2. Choose a row that has nothing entered in it by selecting the area in the *Device (ECU)* column. (Notice that the selectable areas on this screen have a light grey background color).
3. Press the **Add** button.

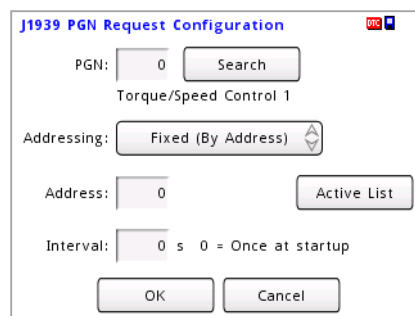

4. Press the **Search** button to display the *SPN Search* screen and then search by PGN or SPN to obtain the PGN you need.
5. Select a device to choose the ECU you want to begin transmitting the data for the PGN you selected.

If you know the address of the device (ECU) that is supplying the data for the selected SPN you could specify an addressing mode of *Fixed (By Address)* and then enter the address, or use the **Active List** button to choose it. Likewise, if you have a user defined device you can select the *Arbitrary (By Name)* addressing mode and then press the **Device List** button. The *All Devices* option will cause all ECU to transmit the selected PGN data if it can.

6. Enter an interval for how often that data should be transmitted. A value of zero means that the data will be transmitted only once the ECU is started up.
7. Press **OK**.

10.7 Diagnostic Trouble Codes

The SmartVue can monitor diagnostic messages, commonly referred to as DM messages, from a selected device on the network. The SmartVue supports DM1 messages, which provides a list of diagnostic trouble codes (DTCs) that are currently active on the device. Up to ten active DTCs can be monitored from a selected ECU (even though a device may transmit more than ten). Each DTC incorporates the diagnostic lamp statuses, the source SPN, the SPN Conversion Method (CM)[†], a Failure Mode Identifier (FMI) and the Occurrence Count (OC).

10.7.1 Configuration

➤ **To monitor any active DTCs that may be on the bus**

1. Select **Diagnostics Config** from the *J1939 Menu*.
2. Choose a row that has nothing entered in it by selecting the area in the *Device (ECU)* column. (Notice that the selectable areas on this screen have a light grey background color).
3. Press the **Add** button.
4. Choose the device you wish to monitor for DTCs.

You can choose a device by using the *Fixed (By Address)* addressing mode. In this case enter an ECU address or choose a device from the *Active Device List* by pressing the **Active List** button and selecting it. Alternatively, you can choose a device from the *User Device List* using the *Arbitrary (By Name)* addressing mode.

Press **OK** to return to the *Diagnostics Configuration* screen.

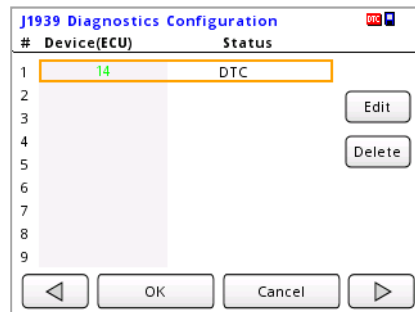

#	Device(ECU)	Status
1	14	DTC
2		
3		
4		
5		
6		
7		
8		
9		

5. Press **OK**.

[†] The Conversion Method (CM) specifies how the bits identifying the SPN should be converted into the actual SPN value. The recommended standard, Version 4, is assumed.

10.7.2 Viewing Active DTCs

DTCs can be viewed using the *Active DTC Monitor* screen (**J1939 – Menu > Diagnostics Display**).

There are two sets of four lamps: MIL, STOP, WARNING, and PROTECT. Depending on the trouble code, one or more of these lamps will light up or flash to indicate the severity of the problem. A rapid flash (about 1 Hz) indicates a problem with a greater severity than if it were flashing slowly (about 2 Hz), and a slow flash has a higher severity than no flash (but illuminated).

There are two portions to the screen. The upper portion of the screen shows the combined lamp states for all of the DTC messages from the indicated ECU. Thus if one DTC were to cause the Malfunction Indicator lamp to be illuminated and another DTC to cause the Warning lamp to be illuminated, they will both be illuminated simultaneously.

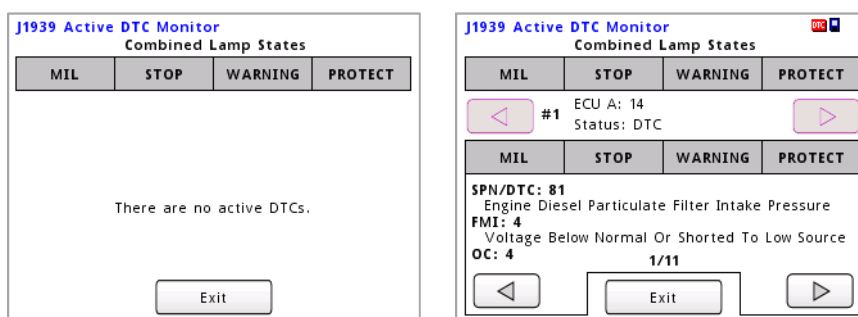

Figure 10-7 The Active DTC Monitor screen

On the lower portion of the screen, you can page through each DTC for the selected ECU by using the arrow buttons. The lower lamps will indicate the severity for the single DTC only. In this case, different DTC may illuminate the lamps differently.

You can cycle through the list of selected devices using the arrow buttons to examine the combined lamp states.

Table 10-1 Status lamps and their meanings

MIL (Malfunction Indicator Lamp)	This lamp is used to relay trouble code information related exclusively to emissions-related issues. It will illuminate only when there is an active emissions-related DTC.
Red Stop Lamp	Trouble code information that is of a severe enough condition that stopping the vehicle is warranted will cause this lamp to illuminate.
Amber Warning Lamp	A DTC for a problem with the vehicle system where the vehicle does not need to be immediately stopped will cause this lamp to illuminate.
Protect Lamp	This lamp is used to relay trouble code information for a problem that is probably not electronic subsystem related.



DTC Icon

If there are one or more devices listed on the J1939 Diagnostics Configuration screen and one (or more) is transmitting a DTC, then the DTC icon shown here will be displayed in the upper right corner of the display.



11.0 Serial Data Communications

The SmartVue is equipped with one RS-232 serial interface and one RS-485 serial interface for serial data communications. Each is independent of the other and can have their own separate configuration settings. The following serial communications modes are available:

Stream – Textual lines with comma separated fields of data selected from process data, IO data, and J1939 SPN, and DTC data. The data output is organized with the same format as Ethernet data communications described in section 9.4.

MB ASCII – (Used for Modbus serial communications) Modbus ASCII uses ASCII characters to represent the data and uses LRC error checking. More bytes are needed to transmit message content than with MB RTU.

MB RTU – (Used for Modbus serial communications) Modbus RTU uses binary coding and CRC error checking. Fewer bytes are need to transmit message content than with MB ASCII.

Since MB ASCII and MB RTU are incompatible, you must know how the device that the SmartVue is communicating with is configured and then configure the SmartVue to use the same method. Refer to section 12.0 for setting up Modbus Register.

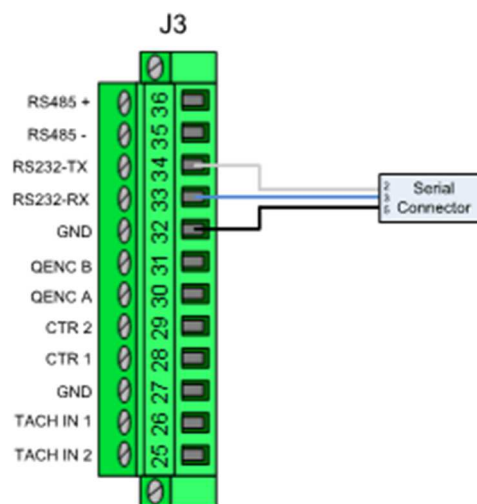

11.1 Streaming Serial Data

The SmartVue can stream process data, IO data, and J1939 SPN and DTC data via the serial RS-232 and RS-485 ports.

Using the *Auto Send* feature, you can specify that certain data automatically begin streaming when the SmartVue is started without the need to first send a command to request it. A new terminal session formed with the *Auto Send* feature turned on will also immediately begin to display data.

As with Ethernet data communications, commands can be sent to the SmartVue using a serial terminal application. (An example application is discussed in a later section.) Refer to section 9.3 for the command syntax.

Likewise, for testing purposes the command checksum can be disabled. For example, if you wanted to conveniently obtain data or to test a connection via a Telnet session without having to calculate the checksum you can disable the checksum requirement.

➤ To configure the SmartVue to stream process data via RS-232

1. Select **MENU > Communications > Serial Settings > RS232 Settings**. (Select **RS485 Settings** if you wish to use the RS485 interface.) If the serial interface is off, you will see a single control called **Serial Mode**.
2. Set the **Serial Mode** control to *Stream*. (Note: selecting *Off*, shuts off the serial communications interface.) This will display the screen shown below.

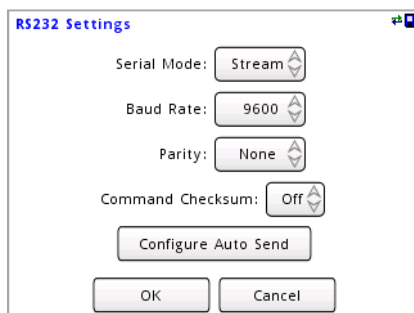

Figure 11-1 RS232 Settings

3. Set the **Baud Rate** to the desired value. Options include: 600, 1200, 2400, 4800, 9600, 14400, 19200, 38400, 57600, and 115200.
4. Set the **Parity**. The options are Odd, Even, or None.
5. The **Command Checksum** setting is set to **Off** by default. The *Off* setting will accommodate testing and allow you to manually send commands to the SmartVue without having to include, and thus calculate, the checksum. With the checksum turned on, commands will require that the correctly computed checksum value be included; without it an error response will be generated.

- Optionally, if you wish to select which sets of data will be sent automatically when the SmartVue is powered up, press **Configure Auto Send**. This will display the *Auto Send* configuration screen.

Set **Auto Send** to **On** to activate this feature.

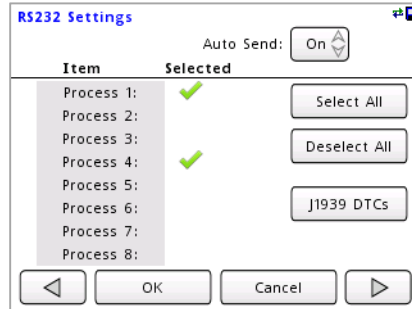
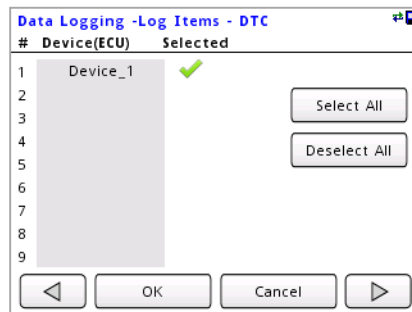

Figure 11-2 RS232 Settings – Configure Auto Send screen

Select items from the *Item* column for the data sets you wish to receive. Press **Select All** to check all of the boxes at once or **Deselect All** to uncheck all of them. (Note, remember to save the SmartVue's settings if you want your selection to persist after it's been powered off.)

Also, optionally, if the J1939 communications stack is enabled then active Diagnostic Troubleshoot Codes (DTCs) can also be streamed for devices (ECUs) that have been added using the J1939 Diagnostics Configuration screen. Press the **J1939 DTCs** button to display them and then select the ones you want to receive streamed data for by pressing the device name. If the list is blank, no ECUs have yet been selected through the J1939 Diagnostics Configuration. (Refer to Section 10.7 for more information regarding DTCs.)



Press **OK** to accept your changes and then **OK** again to return to the previous screen.

- Press **OK**. You should now be back on the initial RS232 Settings screen.
- Press **OK** to apply your changes.

Section 9.3 described the use of a program called PuTTY to use with Ethernet data communications. Here we'll demonstrate how to use it to communicate with the SmartVue serially.

The two screens below show how PuTTY is configured to communicate over comport 4 (called COM4) at 9600 baud with no parity. Note that the SmartVue uses 8 data bits and no flow control by default so the PuTTY configuration should also reflect this.

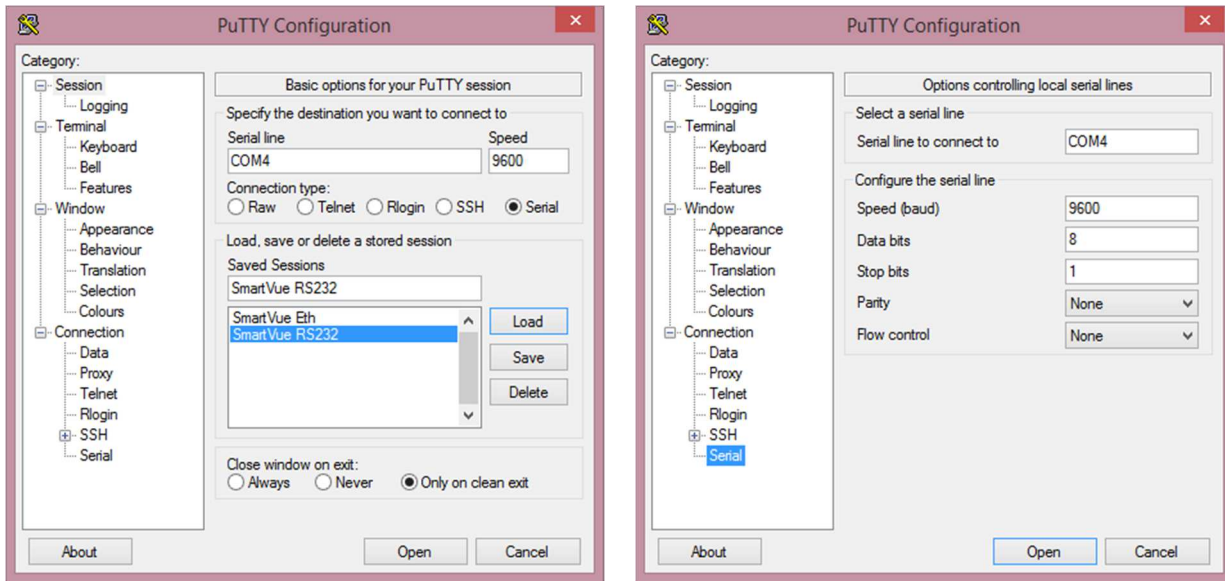

Figure 11-3 Serial communications using PuTTY

Save the configured session and click **Open** to observe the streaming data. This figure below shows RTD temperature data coming from Process 1.

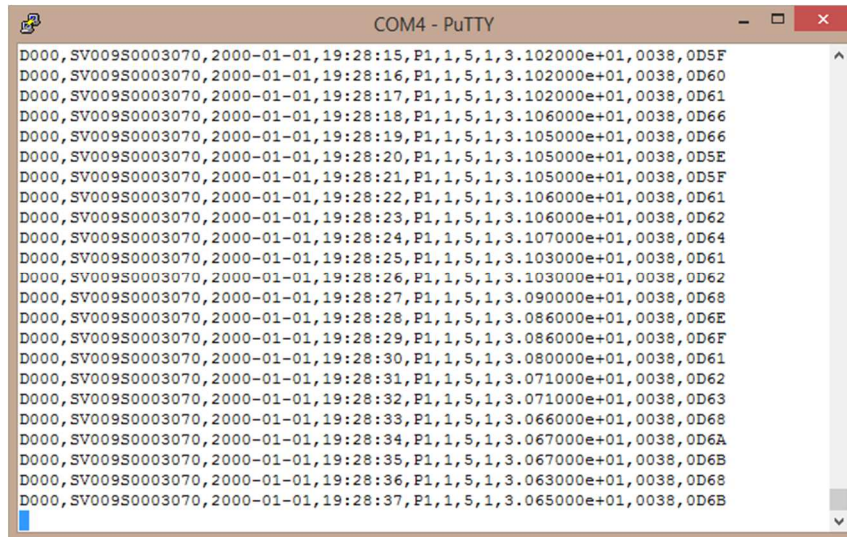

Figure 11-4 Sample serial data using PuTTY

12.0 Modbus Communications

Modbus is a serial communications protocol that is widely used in industry to connect multiple devices on the same serial network. The SmartVue acts as a slave device and can use its serial port interfaces to send data using the Modbus protocol. Other devices can thus use the serial Modbus link to read selected registers and retrieve the desired data point from the SmartVue.

The SmartVue provides Modbus ASCII and Modbus RTU communication methods and currently supports function codes 2 and 4 for reading discrete inputs and floating point input registers respectively.

Appendix 21.4 lists the complete Modbus register mappings for reading all of the SmartVue's I/O points, the user configurable register assignments related to any active process along with possible error codes, and the J1939 SPN and DTC data and statuses at their fixed register locations.

12.1 Reading Process Data

➤ **To configure the SmartVue to use serial Modbus communications**

1. Select **MENU > Communications > Serial Settings > RS232 Settings**. (Select **RS485 Settings** if you wish to use the RS485 interface.)
2. Set the **Serial Mode** control to either **MB RTU** or **MB ASCII** depending on the type of Modbus protocol being used on the network. (Note: selecting *Off*, shuts off the serial communications interface.) This will display the screen shown below.

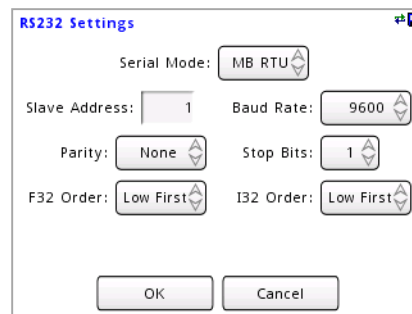

Figure 12-1 RS232 Settings with MB RTU serial mode

3. Set the **Slave Address** for the SmartVue between 1 and 247. The value should not conflict with any other devices on the Modbus network.
4. Set the **Baud Rate** to the desired value. Options include: 600, 1200, 2400, 4800, 9600, 14400, 19200, 38400, 57600, and 115200 bits per second.
5. Set the **Parity**. The options are Odd, Even, or None. This should match the configuration of the master device.
6. Set the **Stop Bits** to either 1 or 2. This should match the configuration of the master device.

7. Set how 32-bit wide data should be transmitted: high order register first or low order register first. This can be set separately for floats and integers.
8. Press **OK** to apply your changes.

➤ **To select a Process data register to read using Modbus**

1. Select **MENU > Communications > Modbus Registers > Process/Control Registers**.
2. Select a vacant Process/Control register address and then press **Add**. Available Process/Control registers range from 201 to 263. Use the arrow buttons to navigate the range of registers.
3. On the selected Modbus Register screen, choose the Process or Control Process that you wish to provide a data point for. (Only enabled processes will be available). Next, choose the **Data Point**, which will either be a measured value or its status (the type of process or a potential error code).

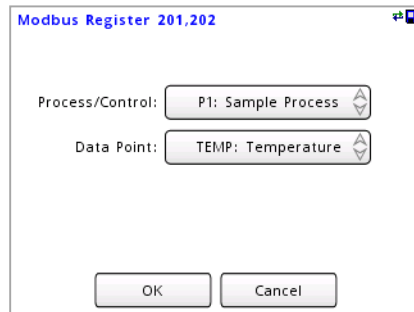

4. Press **OK**. The selected process will be listed on the Modbus Process/Control Registers screen. In this example, an RTD temperature sensor is connected and Process 1 is configured to handle the input data.

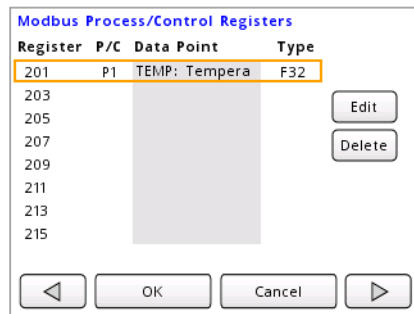

5. Press **OK** to apply your changes. In this case, the 32-bit floating point temperature data is now available for reading via Modbus from register 201.

12.2 Reading J1939 Data

The SPN data, which can be either floating point or integer, can be accessed via Modbus over the Input Register range of 1003 to 1048. The data is two bytes wide, thus the first data value is contained in registers 1003 to 1004, the second in registers 1006 to 1007, and so on.

Input Register (Function Code 4 - Read Only)				
Address	Register ID	Modcon	Tag	Status/Data
1000	1001	31001	J1939STATUS	Status
1001	1002	31002	SPNSTATUS1	Status
1002	1003	31003	SPNDATA1	Data
1004	1005	31005	SPNSTATUS2	Status
1005	1006	31006	SPNDATA2	Data
...

The status of each SPN data register is also available with the first SPN status register being 1002, the second, 1005, and so on. The following table summarizes the meaning of each bit position if set.

Bit Position	Description
0	No Data
1	Timeout
2	Over Range
3	Under Range
4	Stack Not Running
5	Data is Integer
6	Disabled

Register ID 1001 (address 1000) stores the status of the J1939 stack as an integer value.

J1939 Stack Status	Description
0	Disabled
1	Claiming
2	Claim Failed
3	Initialized
4	Running
5	Internal OS Error

When monitoring selected SPN data, the register assignments can be examined using the *View J1939 SPN Registers* screen.

➤ To view the J1939 SPN Register assignments

- Select **MENU > Communications > Modbus Registers > View J1939 SPN Registers**.

Refer to Appendix 21.4.4 for the complete list of Modbus Input Registers that are available for reading SPN data.

When reading the DTC data, up to 16 separate ECUs can be simultaneously monitored. With each ECU, access to its status, lamp state, and the number of codes that have been produced is available. Up to 10 DTCs along with their related FMI (Fault Mode Identifier) and OC (Occurrence Count) information can be accessed for each ECU.

The table below shows the registers and accompanying data for the first ECU followed by two sets of DTC data (four registers each). Refer to Appendix 21.4.5 for a more complete table.

Table 12-1 DTC Modbus register mapping

	Address	Register ID	Modcon	Data
	1100	1101	31101	STATUS1
ECU1	1101	1102	31102	ECU1
	1102	1103	31103	LAMP1
	1103	1104	31104	NCODES1
	1104	1105	31105	DTC1-1_H
DTC1	1105	1106	31106	DTC1-1_L
	1106	1107	31107	FMI1-1
	1107	1108	31108	OC1-1
	1108	1109	31109	DTC1-2_H
DTC2	1109	1110	31110	DTC1-2_L
	1110	1111	31111	FMI1-2
	1111	1112	31112	OC1-2

13.0 Updating the Firmware

The SmartVue's embedded firmware can be updated when new releases become available that expand or improve functionality. Updates will be made available on Dycor's website or can be e-mailed directly to the customer as needed. Some updates will be provided freely while others may require a license.

Updates are in the form of a SmartVue Application file ending with a .sva extension. Updating does not affect stored configuration settings.

➤ To upload a new firmware version

1. Press **Menu > SmartVue > Upload Firmware**. This will display the message shown in the figure below.



2. Copy the SmartVue application file to a USB flash drive and insert it into the USB port on the back of the unit, then press **OK**. (Pressing **Cancel** will return you to the SmartVue menu without updating the unit.) The SmartVue Application Loader will begin and display the following message:



3. The Application Loader will detect the .sva file and display a message similar to the one shown below.



Press **OK** to proceed. Pressing **Cancel** will reset the SmartVue without updating it. The following screen will be displayed to indicate the progress of the firmware programming stages.

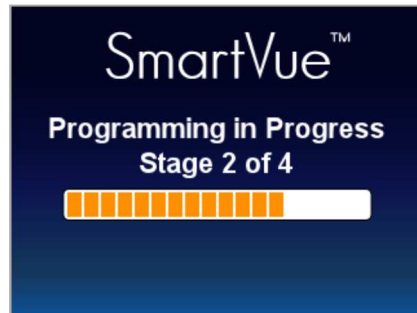

Once updating is completed, the SmartVue will prompt you to touch the screen so it can initiate a reset. During the reset you may see the message, "Uploading DSP firmware" at which time the digital signal processor firmware will also be updated.

4. Remove the USB flash drive.



Updating When Powering On

If the unit is off you can press and hold on the touch screen while the unit is powered on. If a USB flash drive is not detected the touch screen calibration feature will start followed by the brightness adjustment screen for the LCD, you'll then be prompted to insert a USB flash drive containing a file for the new firmware if you wish to update the firmware to a new version. If the USB drive is already inserted the touch screen calibration and brightness adjustment steps will be skipped.



Save Time Upgrading Multiple Units

You can actually remove the USB flash drive after Stage 1 of 4 is completed. This will help you save time if you are upgrading multiple SmartVue's with a single flash drive.

14.0 Password Protection

Several screens can be password protected to prevent important configuration settings from being changed indiscriminately. For example, you may want to “lock” certain process configurations if they are measuring or controlling a critical task.

When password protection is turned on, a small lock icon will appear in the upper right corner of the screen. The icon will also indicate whether or not the unit is “locked”. The icon appears unlocked if a user is logged in and locked when logged out.



The following menu items are locked when password protection is turned on and a user is not logged in:

- Main Menu
 - Processes
 - Locked process (user selectable)
 - Control Processes
 - Locked control processes (user selectable)
 - Configure I/O
 - Set Outputs
 - Communications
 - File System
 - Load Default Settings
 - SmartVue
 - Password

➤ To turn on password protection

1. Select **MENU > SmartVue > Password**.
2. Enter the same password in the **Password** and **Confirm** fields. You can also reuse a previously stored password.
 - The password must be between 2 and 10 characters in length and contain only letters and numbers. Spaces and symbol characters are not allowed.
 - If you're logged in you can change the password.
3. Press the spinner control to indicate **On**.

4. Press **OK**.

The unit will be in an unlocked, or 'logged in' state, following the setup of password protection. To lock the unit you must log out by pressing the **Logout** button on the *SmartVue* menu screen.

If password protection is turned on you can log into the SmartVue by entering the password. An error message will be displayed if you try to log in and password protection is shut off.

➤ **To log into the SmartVue**

1. Select **MENU > SmartVue > Login**. (The button will display the word "Logout" if you're already logged in.)
2. Enter the password.

Press the button again to log out.

Notes:

- When you turn on password protection, don't forget to use the **Save Settings** feature to save the password and on/off setting, otherwise if the unit is shut off it will not be password protected when you turn it back on.



What if I forget my password?

If you forget your password and you become locked out, you will have to upload a previous version of the firmware, use the *Save Settings* feature to overwrite the stored settings and then upload the current firmware again. You will lose your previously stored settings which will revert to factory default values.

Contact Dycor for a SmartVue Application file for a previous version if you do not have one.

15.0 File System

The file system options allow you to store the SmartVue's configuration settings either locally or on a USB flash drive. A configuration file can be loaded again later to restore previous settings or it can be loaded onto another SmartVue so that settings may be replicated from one unit to another.

The file system options are available from the *Main Menu*. The *File System* menu is shown below followed by a summary of what each button does.

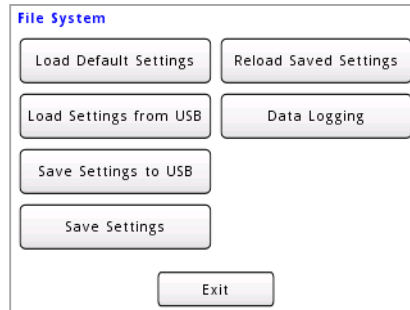

Figure 15-1 The File System menu

The *File System* menu displays buttons for the following options:

Load Default Settings loads the unit's factory settings for all I/O points, processes, meters, and communications configurations. If the default settings are loaded you must still press *Save Settings* to preserve them before powering off the SmartVue.

Load Settings from USB allows you to load a settings file from a USB flash drive. Once loaded, you must press *Save Settings* to keep the new settings. Press *Save Settings* to preserve the newly loaded settings before powering off the SmartVue.

Save Settings to USB lets you save the SmartVue's current settings to a file on a USB flash drive. File names are assigned a default value consisting of a number sequence indicating the current date and time (with the format *YYMMDDhhmm*), but you can also specify your own file name. SmartVue configuration files are given the extension *.svc*.

Save Settings saves the SmartVue's current settings to internal memory.

Reload Saved Settings reloads the last saved settings saved to internal memory. If changes are made to the settings and are not yet saved, you can quickly restore them using this option.

Data Logging displays the *Data Logging* menu. Options for enabling logging and configuring the frequency, format and contents of logged processes, I/O, and J1939 data are provided.



Passwords are not saved within the settings file

The password and the password protection setting are not saved as part of the settings file when saved to a USB flash drive, nor are existing password settings overwritten when a settings file is loaded.



Loading a new configuration disables processes and outputs

Loading new settings means new SmartVue processes and output settings could be loaded overtop of existing ones. As a result, the new processes will not be automatically started. This is to give you the opportunity to review the configuration for validity prior to running them since any connected devices, circuits or sensors could also be affected leading to undesirable and possible detrimental consequences.

15.1 Saving and Loading SmartVue Settings

➤ **To save the SmartVue's configuration to a USB flash drive**

1. Insert a USB flash drive into the USB port.
2. Select **Main Menu > File System > Save Settings**.

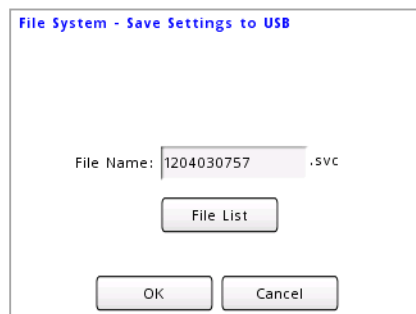

3. Use the **File Name** text control to specify a name for the configuration file or accept the default file name indicating the current date/timestamp (in the format *YYMMDDhhmm*).

If you wish to overwrite an existing file, press the **File List** button to display the list of configuration files on the USB flash drive, select the file name of the file you wish to overwrite, and then press **OK**. The selected file name will then appear in the **File Name** text control.

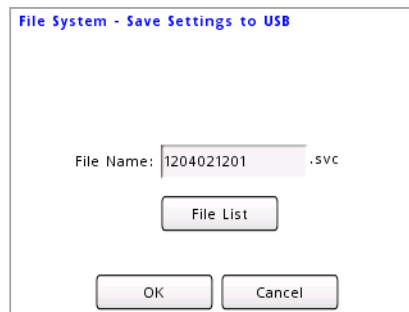
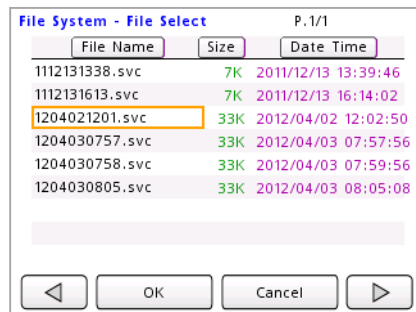

4. Press **OK** to save the configuration file.



5. Press **OK**.

➤ **To load a SmartVue configuration file from a USB flash drive**

1. Insert a USB flash drive into the USB port.
2. Select **Main Menu > File System > Load Settings**. This will display a *File Select* screen listing all .svc files on the flash drive along with the file size and a Date/Timestamp. Press a file name to select it.

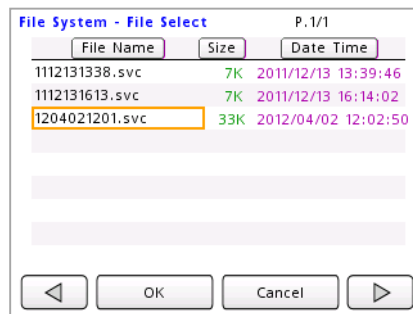

3. Press **OK**. When loading a configuration file, you have the option of preserving the current Ethernet and/or J1939 communications settings without overwriting them with the settings in the file. Specify *Yes* if you wish to load the settings stored in the file you selected.

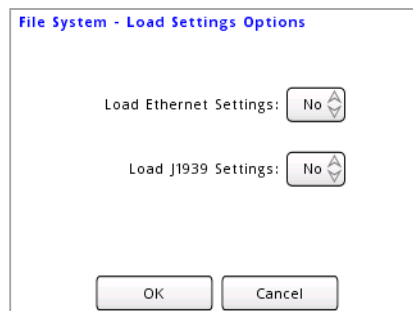

4. Press **OK**. A warning message is displayed to remind you that the newly loaded processes and outputs will be disabled until they are manually run.



5. Press **OK**.

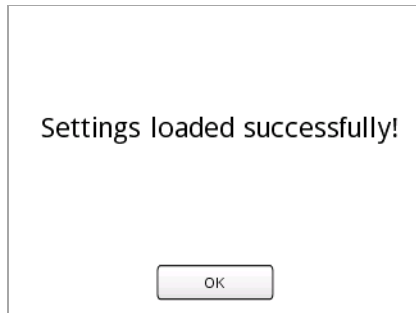

6. Press **OK**.

7. The blue frame around the screen indicates that the newly loaded processes are not running and the outputs have been turned off. In addition, each meter on the *Meter* screen will indicate this by displaying the message “DISABLED”.

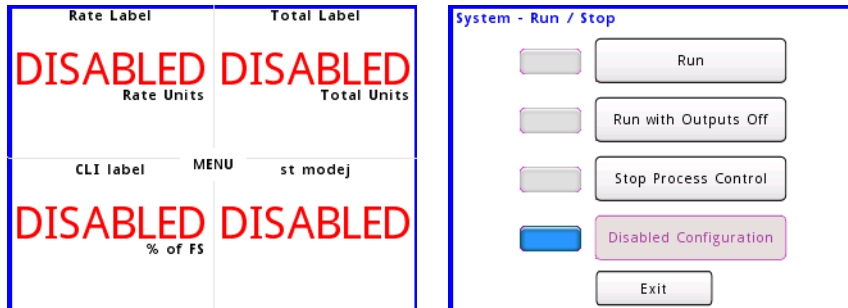

Once you are satisfied that the unit is physically connected and configured in a fashion that is suitable for your application, you can run the configured processes and engage the outputs by selecting *Run* on the *Run / Stop* screen, which is accessed from the *Main Menu*.

16.0 Data Logging

When enabled, the SmartVue can log data to its internal flash memory from any of the following sources:

- Processes 1-8 (selectable)
- Control processes 1-2 (selectable)
- Inputs/Outputs
- J1939 SPN data
- J1939 DTCs (selectable)

The data logging feature is accessed from the Main menu > File System.

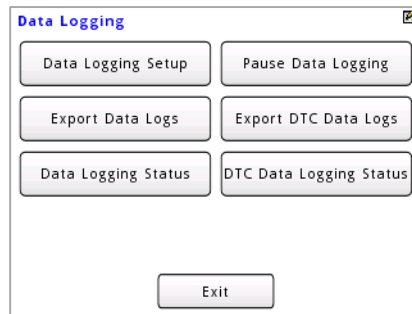

Figure 16-1 The Data Logging menu

The *Data Logging* menu contains the following options:

Data Logging Setup displays configuration options for enabling logging and configuring the frequency, format and contents of logged processes, I/O, and J1939 data.

Export Data Logs allows you to copy one or more data logs to a USB flash drive.

Data Logging Status displays a screen that reports information about log file memory usage.

Pause/Resume Data Logging lets you pause or resume data logging activity.

Export DTC Data Logs allows you to copy one or more DTC data logs to a USB flash drive.

DTC Data Logging Status displays a screen that reports information about DTC log file memory usage.



Data logging and power loss

If power is shut off or lost while data logging is progress the SmartVue will automatically resume logging when power is restored. The file that was being logged to will be preserved and a newly generated data file will continue with storing the data.

Likewise, if the SmartVue's date or time is adjusted while data logging is in progress, a new file will be created at that moment so that the time stamped data (and log file names that are named with a time stamp) accurately references the newly set time.

16.1 Data Logging Setup and Status

The *Data Logging Setting* screen is used to enable data logging, set the data log file name, specify the logging period, what will be logged, and how data is stored to the internal flash memory.

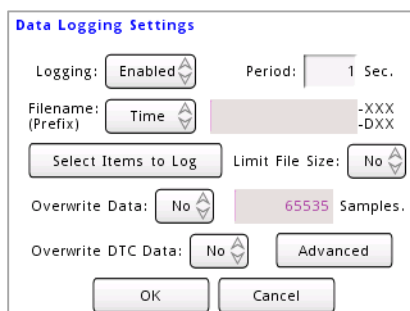
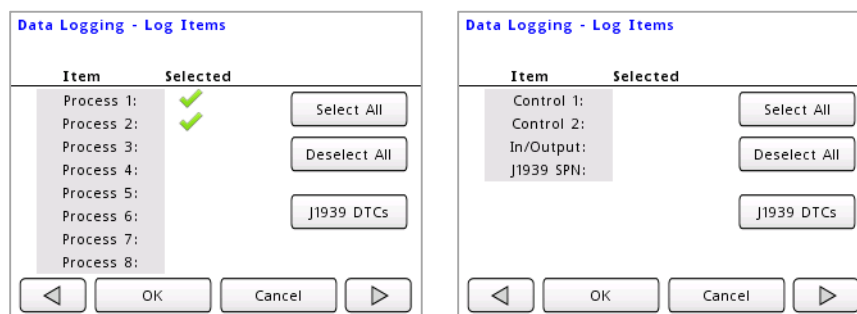

Figure 16-2 Data Logging Settings screen

➤ To setup data logging

1. Access the Data Logging Settings screen. (Select **MENU > File System > Data Logging > Data Logging Setup.**)
2. Set **Logging** to **Enabled**. Set it to **Disabled** to discontinue data logging.
3. The **Filename (Prefix)** spinner control can be set to either **Time** or **Name**. The *Time* setting will cause file names to be prefixed with a timestamp value corresponding to its creation date and time with the format *YYYYMMDDhhmm-xxx*. If set to *Name*, you can supply your own custom prefix up to 12 characters in length. A three digit numerical index will follow the name to differentiate between separately generated files. DTC data logs will include a 'D' in the index part of the file name.

Press **Select Items to Log**. Select any of the items by tapping their respective names in the Item column. A green checkmark symbol will appear next to each selected item. Use the **Select All** or **Deselect All** buttons to save time choosing items. Use the navigational arrow buttons to view additional items. Press **OK** when you are finished selecting items.



4. Likewise, you can press the **J1939 DTCs** button to select any active J1939 devices so that related DTCs can be logged.

5. Specify whether or not you wish to limit the number of samples that will be recorded in each log file. If the **Limit File Size** spinner is set to **Yes** you can specify a limit in the numeric **Samples** field. The default value of 65,533 samples, for example, would be compatible with older versions of spreadsheet software, allowing all of the data plus the header rows to be loaded. If the setting is set to **No**, there will be no sample limit to individual log files.
6. Optionally, you can configure additional settings to control how the data will be stored:

Overwrite Data

If **Yes** is specified, then when the internal storage capacity has been reached during logging, older files will be overwritten with new data for the current data file. If **No** is selected, data logging will cease when the storage capacity is reached.

Overwrite DTC Data

If **Yes** is specified, then when the internal storage capacity has been reached during logging, older files will be overwritten with new data for the current DTC data file. If **No** is selected, data logging will cease when the storage capacity is reached.

Advanced

The *Advanced Settings* screen allows you to specify a maximum number of samples that will be logged. Logging stops when the maximum is reached.

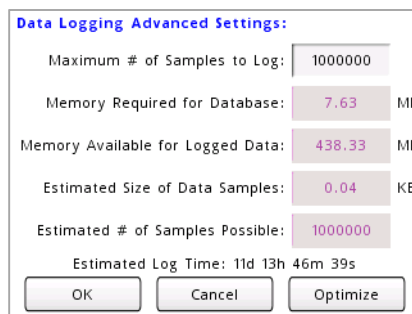

Data Logging Advanced Settings:		
Maximum # of Samples to Log:	1000000	
Memory Required for Database:	7.63	MB
Memory Available for Logged Data:	438.33	MB
Estimated Size of Data Samples:	0.04	KB
Estimated # of Samples Possible:	1000000	
Estimated Log Time: 11d 13h 46m 39s		
<input type="button" value="OK"/> <input type="button" value="Cancel"/> <input type="button" value="Optimize"/>		

Additional information about available storage, sample size and the time left until capacity is reached is also given.

When you press the **Optimize** button, the SmartVue will calculate the optimal size for each sample for only the selected data source items as opposed to a larger size that can handle all potential data sources. This has the effect of increasing the available memory for logged data and, in turn, the number of samples that can be logged.

7. Press **OK**. Data logging will now begin.

If you have changed the Advanced Settings (the maximum number of samples setting) you will see the following warning:

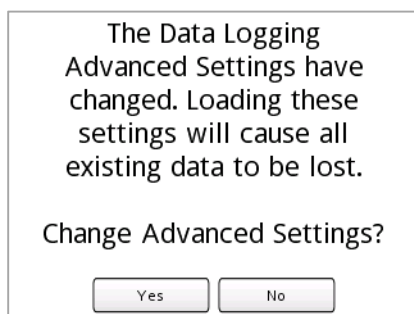

If you select **Yes**, the currently stored log files will be lost. If you select **No**, the Advanced Settings will revert to their previous values and your data files will not be lost. This warning can appear anytime a configuration is loaded and the number of samples is different.



Changing Advanced Settings

If you change the Advanced settings all of the data logs that are currently stored will be lost to accommodate the newly selected data storage structure. You may want to export data logs to a USB flash drive before making changes to the Advanced Settings.

Notes

- Data log files are automatically appended with a *.csv* extension designating it as a *comma separated values* file. *.csv* files can be directly opened by text editors and spreadsheet programs such as Microsoft Excel®.
- For time stamped file names, you will only see the numerical index increment from 000 if a new data log file is generated within the same minute as the previous log file with the same timestamp.
- One of the following icons will appear in the upper right corner of the display when data logging is enabled.

Icon	Description
	Data logging is enabled
	Data logging is paused
	The data logging memory is full
	The data logging memory is full and paused

The data logging status screen provides information about the number of files stored, number of samples taken, and the amount of memory consumed. The amount of time

remaining for data logging to continue with the current configuration setup (without overwriting old data) is also displayed.

➤ **To display the current data logging status**

Select **MENU > File System > Data Logging > Data Logging Status**.

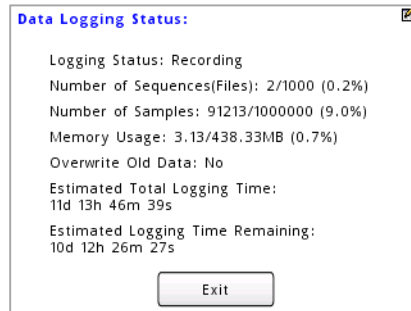

Figure 16-3 The Data Logging Status screen

Note: the *Estimated Logging Time Remaining* will not be displayed if the *Overwrite Data* option is enabled.

16.2 Exporting and Deleting Data Logs

Internally stored data logs can be exported to a USB flash drive using the procedure below. Data logs can also be deleted to free up storage space.

➤ **To export data logs to a USB flash drive**

1. Select **MENU > File System > Data Logging > Export Data Logs**. (Select **Export DTC Data Logs** to copy DTC data to a USB flash drive.)
2. In the **File Name** column select the data logs you wish to export. Selected files will be highlighted green. Additional log files may be listed on additional pages. All of the data logs can be quickly selected by pressing **Select All**.

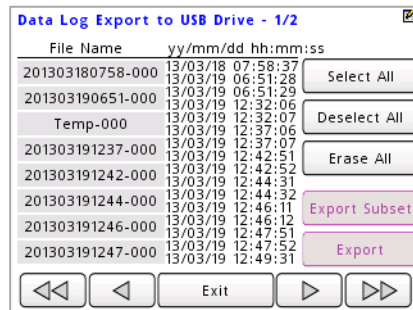

Additional navigational arrow buttons will appear once the number of file names exceeds a complete page.

The single-arrow buttons advance forward or back one page at a time and will wrap around in the page count.

The double-arrow buttons advance 10 pages at a time or to the first/last pages if there are less than 10 pages.

3. Press **Export**. A warning screen will appear. Note that data logging is paused during the export process. Press **OK** to continue.



4. Make sure a USB flash drive is inserted into the USB port on the back of the SmartVue and then click **OK**. (A warning message will appear if one is not detected.)



5. When the export is finished press **OK** to return to the *Data Log Export* screen.

It is possible to export a subset of Process, Control Process, and I/O data from a selected log file. This is helpful when you have a large log file and want to save time exporting only the relevant data you need from a desired time range.

➤ **To export a subset of data from a log file**

1. Select **MENU > File System > Data Logging > Export Data Logs**.
2. In the **File Name** column select a single data log file you wish to export a subset from.

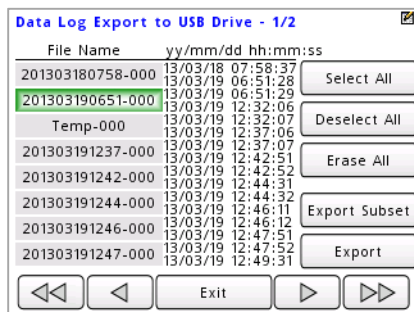

3. Press **Export Subset**. A warning screen will appear. Note that data logging is paused during the export process. Press **OK** to continue.

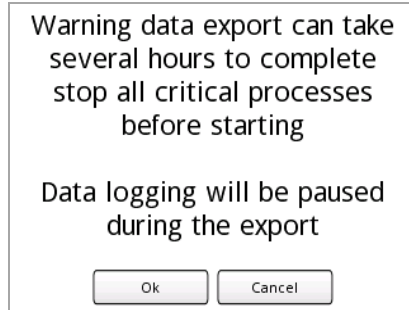

- Using the **Start** and **End**, date and time fields, select the range for the data within the data log you wish to export.



- Click **OK**.



- When the export is finished press **OK** to return to the *Data Log Export* screen.

➤ **To erase all data log files**

- On the Data Log Export screen press **Erase All** and then press **OK**.

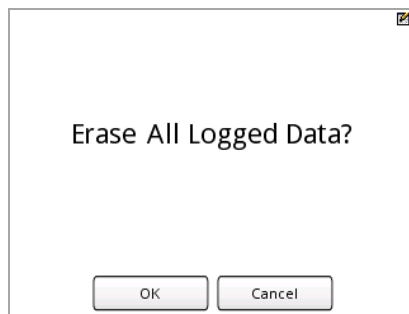

All data logs will be deleted. If data logging is enabled, a new data log file will be immediately created and logging will resume.

16.3 Pausing Data Logging

There will be times when you will want to modify physical I/O connections or make configuration changes. This may also be a time when you want to pause data logging to avoid storing unneeded or ambiguous data while settings are being changed.

To pause data logging, press the **Pause Data Logging** button on the *Data Logging* menu. Press it again to resume logging.

17.0 SmartVue Configuration

This section discusses the display configuration settings and other informational screens.

17.1 Display Brightness

The brightness, and to a certain extent, the viewing angle of the LCD display, can be adjusted as desired between values of 0 and 100%.



Figure 17-1 Brightness configuration screen

➤ **To adjust the display brightness**

1. Press **MENU > SmartVue > Brightness**.
2. Press the left and right arrow buttons to decrease or increase the brightness value between 0 and 100%.
3. Press **OK**.



Brightness and High Temperature

In high ambient temperatures the SmartVue will automatically limit the maximum brightness to a value lower than the user's setting to prolong the life of the LCD's backlight. When this occurs the message, "High Temperature! Brightness limited to x%" will be displayed on the Brightness configuration screen where x% is the temporary brightness limit.

17.2 Touch Screen Calibration

If the touch screen does not respond appropriately to presses, or the alignment of touches does not match properly with buttons, then it may need to be calibrated. Note that on occasion a button may need to be pressed more than once (for example, if it is touched too lightly), but this does not necessarily mean that the touch screen is out of calibration.

➤ **To calibrate the touch screen**

1. Press **MENU > SmartVue > Calibrate Touchscreen**. This will display the screen shown in Figure 17-2.

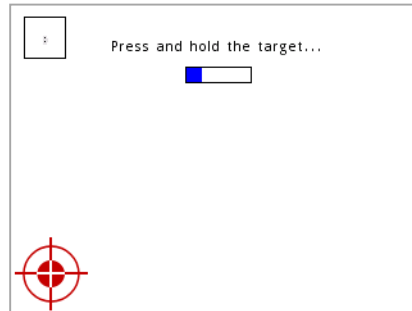

Figure 17-2 Touch Screen Calibration screen

2. A small target icon will appear on the screen. Press and hold it for the duration indicated by the progress indicator, then release; the target will disappear and reappear in another location. Repeat this process for the two remaining targets.

For a more precise calibration you should keep your finger still in the center of the target. The small square in the upper right indicates the level of precision with a distribution of measured points. Below, the image on the left shows poor precision, while the image on the right shows good precision. If you're unsatisfied with the displayed distribution of points simply release your finger before the progress indicator completes and start again.



You will be returned to the SmartVue menu at the end of the procedure automatically.

17.3 Monitor Data

The *Monitor Data* screen displays all of the inputs and outputs, their labels, measured signal values, and their corresponding scaled values in their specified engineering units set in the (default) *Configure I/O* setup. This screen is useful if you want to monitor all I/O points at once, including ones that may not be assigned to a meter.

Monitor Data			
Input	Label	Signal	Scaled
4-20mA IN 1	CLI Label	0.0259 mA	-24.84 % of FS
4-20mA IN 2	CLI Label	0.0142 mA	-24.91 % of FS
Tach IN 1	Rate Label	0 Hz	0.00 Rate Unit
Tach IN 2	Rate Label	0 Hz	0.00 Rate Unit
Counter 1	Rate Label	0 Hz	0.00 Rate Unit
Counter 2	Rate Label	0 Hz	0.00 Rate Unit
Counter 3	Rate Label	0 Hz	0.00 Rate Unit
DIN 1	DIN Label	LOW	LOW
DIN 2	DIN Label	LOW	LOW
VIN 3	VIN Label	0.0000 V	0.00 VIN Units
VIN 4	VIN Label	0.0000 V	0.00 VIN Units
Temp (RTD)	Temperature	28.0800 °C	82.54 °F
Output			
	Label	Signal	Scaled
4-20mA OUT 1	CLO Label	3.7239 mA	-4.60 CLO Units
4-20mA OUT 2	CLO Label	3.7239 mA	-4.60 CLO Units
0-10V OUT 1	VOut Label	0.0000 V	0.00 VOut Unit
0-10V OUT 2	VOut Label	0.0000 V	0.00 VOut Unit
DOUT 5	DOUT Label	LOW	ON
DOUT 8	DOUT Label	HIz	OFF
FREQ OUT 1	FREQ OUT La	0.00 Hz	0.00 FREQ OUT
FREQ OUT 2	FREQ OUT La	0.00 Hz	0.00 FREQ OUT

Figure 17-3 The Monitor Data screen

Select **MENU > SmartVue > Monitor Data** to display the *Monitor Data* screen.

17.4 Date and Time

The *Date / Time* configuration screen allows you to set the SmartVue's real time clock. The time setting is used to display meaningful values on the horizontal time axis on a meter's history graph and can be displayed in either a 12-hour (showing AM or PM) or 24-hour mode.

➤ To set the date and time

1. Press **MENU > SmartVue > Date / Time**. This will display the screen shown in Figure 17-4.

Date / Time			
Fri Sep 23, 2011 9:42:50 AM			
Month	<input type="text" value="9"/>	Day	<input type="text" value="23"/>
Year	<input type="text" value="2011"/>		
Hour	<input type="text" value="9"/>	<input type="button" value="AM"/> <input type="button" value="PM"/>	
Minute	<input type="text" value="42"/>	<input type="button" value="12 hr."/> <input type="button" value="24 hr."/>	
Second	<input type="text" value="50"/>		
<input type="button" value="OK"/>		<input type="button" value="Cancel"/>	

Figure 17-4 Date / Time screen

2. Press the numerical fields for each date and time value you wish to change.
3. Select **AM** or **PM** and the time display mode: **12 hr.** or **24 hr.**
4. Press **OK**.

17.5 Information

The *Information* screen displays the name and version of the firmware application, the boot loader version, and details that identify the SmartVue itself, such as the model, serial number and manufacturing date. An example of the *Information* screen is shown below.



Figure 17-5 The Information screen

18.0 Self-Preservation

The SmartVue is equipped with an internal heater that allows the LCD display to operate at lower temperatures than would otherwise be possible. Once the internal temperature drops to a certain point the heater will automatically turn on so that the LCD display, and thus controllability of the unit, is maintained. Thus it is normal that the unit will draw more power in colder temperatures.

Also, as noted in Section 17.1 *Display Brightness*, the SmartVue will automatically limit the maximum brightness to a value lower than the user's setting to prolong the life of the LCD's backlight. The message, "High Temperature! Brightness limited to $x\%$ " will be displayed on the Brightness configuration screen when this occurs. x is the temporary brightness limit percentage.

19.0 Boot-up Options

A number of boot-up options are available to allow diagnostic operations or hardware configuration to be performed, such as memory testing and display or touch screen calibration prior to the firmware application being loaded.

To access the *Boot Menu*, press and hold the touch screen when the initial splash screen is displayed just after the unit is turned on or restarted.



Figure 19-1 The Boot Menu

19.1 Testing the SmartVue's Memory

Two memory tests can be conducted to test the integrity of the SmartVue's DRAM and Flash ROM memory. Both tests write and then read back a series of bit patterns to the given integrated memory circuits.

The *DRAM Test* takes about 16 seconds and will not affect the SmartVue in any way. The *Flash ROM* test, however, is invasive and will overwrite the application firmware. This test, which takes about 4.5 minutes, should not be conducted unless you have a copy of the firmware to reload onto the SmartVue on hand. The *All Memory Test* simply performs both tests in succession.

If either test fails the units should be returned for repair.

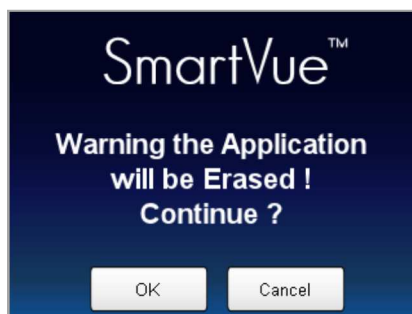

Figure 19-2 The Flash ROM test will require that the application firmware be reloaded

**The Flash ROM Test and All Memory Test Erase the Application Firmware**

The Flash ROM is where the application firmware resides, thus testing it results in the firmware being erased! This test should only be conducted if the memory is suspected of being faulty and you have a copy of the firmware to reload onto the unit after a test that passes is performed.

19.2 System Information

The *System Information* screen displays specific information about the SmartVue including its boot loader version, serial and model numbers, manufacture date and MAC address.



Figure 19-3 Boot loader System Information screen

19.3 LCD Brightness

The LCD brightness can be adjusted between 0 and 100%.

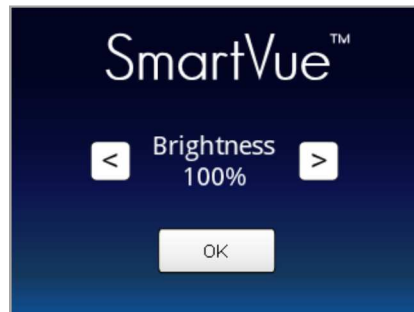

Figure 19-4 Boot loader LCD Brightness adjustment screen

19.4 Touch Calibration

If the touch screen is out of calibration, the SmartVue may not respond properly to touches. If this is the case, you can calibrate the touch screen using the *Touch Calibration* option from the *Boot Menu*. By touching a few target locations on the screen references are provided for calculating the touch locations anywhere on the screen.

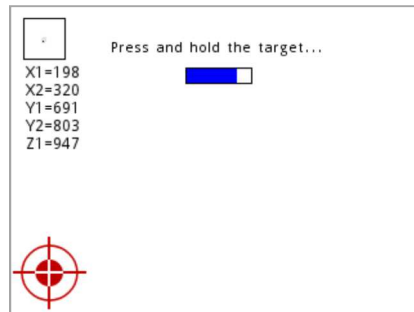

Figure 19-5 Boot loader Touch Calibration screen



Touch Calibration When Touch Control is Lost

The Touch Calibration screen will be entered automatically from the Boot Menu by pressing anywhere on the screen during boot up and waiting for the ten second countdown to complete. This is useful if you have lost touch control of the SmartVue altogether.

19.5 Load Application

The *Load Application* option works the same as described in Section 11.0 *Updating the Firmware*.

19.6 Color Bar

The *Color Bar* screen provides a check that the LCD cable is properly connected to the display mother board. If there are any breaks in the gradients of color then the unit should be returned for repair.

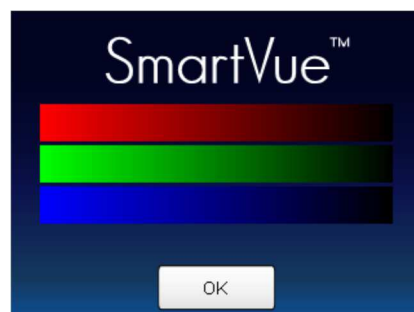

Figure 19-6 Boot loader Color Bar screen

20.0 SmartVue Remote

SmartVue Remote is a Java application that allows remote graphical access to a SmartVue on a TCP/IP network. This is convenient if you have one or more SmartVues on a network that you wish to monitor or control without having to go to the unit(s) directly. Also, multiple SmartVues installed in different locations could be controlled from a central location.

20.1 Requirements

The following are needed to connect to a SmartVue remotely:

- An Ethernet network on which the SmartVue is connected
- Java
- The *SmartVue Remote* Java application (JAR file with bundled *lib* folder)

Java applications require that the Java Runtime Engine (JRE; or simply 'Java') be installed on the computer that will be connecting to the SmartVue. Chances are you already have it installed, but if not it is freely available from the Java website at www.java.com/download/. Once downloaded and executed the installer application will install Java with minimal user intervention.

20.2 Setting Up a SmartVue for Remote Access

Before a SmartVue can accept a connection for remote monitoring or control, it must be configured to allow the connection. Also, the remote user can be granted one of two levels of access: viewing only or viewing with the addition of control.

➤ To setup a SmartVue for remote access

1. Select **MENU > Communications > Ethernet Settings**. The **Ethernet Settings** screen will be displayed.
2. The Ethernet settings must first be configured as described in Section 9.1. An IP Address, Subnet Mask and Gateway must be set. Note the values in the figure are merely examples. You may need to consult your network administrator for values that will work with your network.

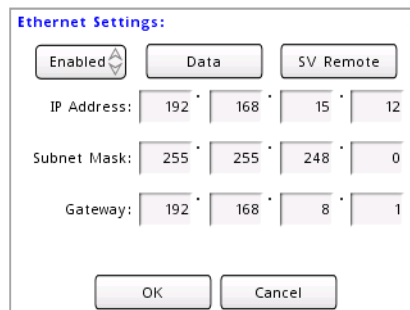

Figure 20-1 The Ethernet Settings screen

3. Press the **SV Remote** button to display the **Remote GUI** screen, then turn on remote access by setting the **SV Remote** button to **On**. The resulting screen is shown below.

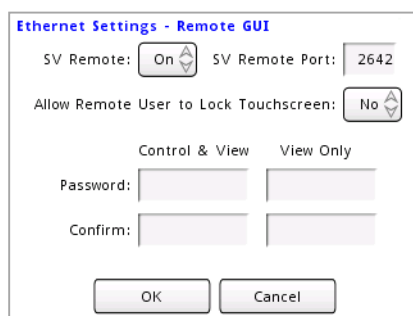

Figure 20-2 The Ethernet Settings - Remote GUI screen

4. Set options.

SV Remote Port The default port for the SV Remote connection is 2642, which should suffice but it can be changed if needed.

Allow Remote User to Lock Touchscreen

If set to *Yes*, the user that is remotely connected can prevent the touchscreen from being used to control the SmartVue. This is useful if you want to configure the SmartVue at the same time someone else has local access and competition for control arises. When the touchscreen is locked the symbol below will be displayed in the center of the screen for the local user.



5. Specify a password for one or both of the strategies for remote access (at least one must be entered). The remote user will be required to enter one of the passwords when attempting to connect to the SmartVue using the *SmartVue Remote* application.

Control & View Allows the remote user to not only see the screen of the SmartVue, but to control is as well using a mouse.

View Only Allows the remote user to view the screen of the SmartVue, but not control it.

If the same password is chosen for both connection methods the connection will default to the **Control & View** type.

6. Press **OK** to return to the **Ethernet Settings** screen.
7. Press **OK** to apply the changes.

When a remote connection has been established with the SmartVue a link icon will appear in the upper right corner of the screen. If it has a red border that means the remote user has locked the touch screen.



Figure 20-3 Link icons

20.3 The SmartVue Remote Application

The *SmartVue (SV) Remote* application is used to make the connection to a SmartVue that is configured to allow remote access, display its screen, and if permitted, allow for remote control of it.

To run *SV Remote*, double click the file, **SV_Remote_Java.jar**.

The application window is show below. When you run the program you will see a “Not Connected” message in the display area, which is normal until you configure the program to connect to the remote SmartVue.

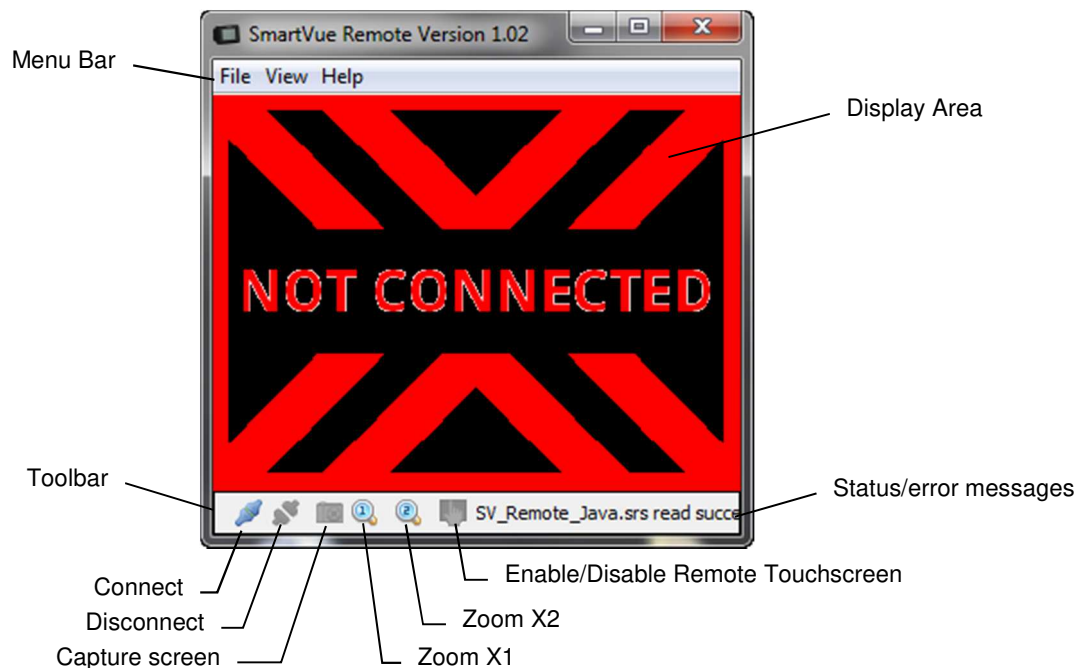

Figure 20-4 The SmartVue Remote program window

20.3.1 SV Remote Settings

You can save your settings to a file so that you won't have to enter them each time you run the application. Also, you can save several settings files for various SmartVues that you may want to connect to.

Connection and display settings are saved in a *SmartVue Remote Settings* (SRS) file.

The application will automatically reload the last SRS file that was used when it is executed.

➤ To configure *SmartVue Remote*

1. Select **File > Settings**. This will display the Settings dialog shown below.

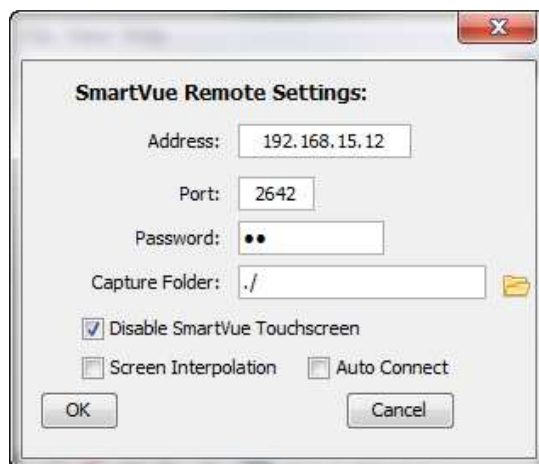

2. In the **Address** field, enter the IP address for the SmartVue you want to connect to. The **Port** value should also match the port number entered in the SmartVue's Ethernet configuration.
3. In the **Password** field, enter the password for the type of connection you will make: **Control & View** or **View Only**. (It's possible that only one may be set on the SmartVue.)
4. The **Capture Folder** is where snapshot images of the screen will be saved when the capture icon is clicked. Use the browse button to navigate to an appropriate location on your hard drive. The default is "./" which means that the images will be saved in the same folder that the application is in.
5. Options

Disable SmartVue Touchscreen

If checked, the connection to the remote SmartVue will initially begin with the unit's touchscreen disabled.

Screen Interpolation

When checked, the display is rendered in such a way as to minimize pixilation when the application window is resized

above the normal x1 dimension. This has the effect of making the rendered display look smoother.

Auto Connect

With this option checked the program will automatically connect with the specified SmartVue when the application is executed without have to select File > Connect or click the Connect icon.

6. Click **OK**.

To save your settings file simply select **File > Save Settings As...**, enter an appropriate file name and click **Save**. Choose **File > Save Settings** if the file has already been created if you make any changes you want to save.

To load a settings file, select **File > Load Settings...**, browse for the desired SRS file, and click **Open**.

20.3.2 Connecting/Disconnecting

Once the settings have been configured for the SmartVue you are intending to connect to you can connect to it.

Multiple instances of the *SmartVue Remote* application may be executed at the same time to connect to multiple SmartVues, but only one remote connection can be made to an individual SmartVue.

To connect to a SmartVue, select **File > Connect** or click the **Connect** icon on the toolbar.

Likewise, to disconnect from a SmartVue, select **File > Disconnect** or click the **Disconnect** icon on the toolbar.

20.3.3 Displaying and Capturing Screen Images

Click the **Capture** icon on the toolbar to take a snapshot of the screen and have it stored on your hard drive in the folder assigned with the *Settings* dialog. Images are 320 x 240 pixels in size (the same as the SmartVue's LCD resolution) and are stored as PNG files less than 10 KB in size.

The application window can be resized to display a larger version of the remote SmartVue's screen by dragging any border or corner. Two zoom options are available in the View menu and on the toolbar: **X1** and **X2** so that you can easily switch between the normal size and a double-sized display.

The message area of the toolbar continuously displays the display refresh rate and size in bytes of the screen image as it is loaded.

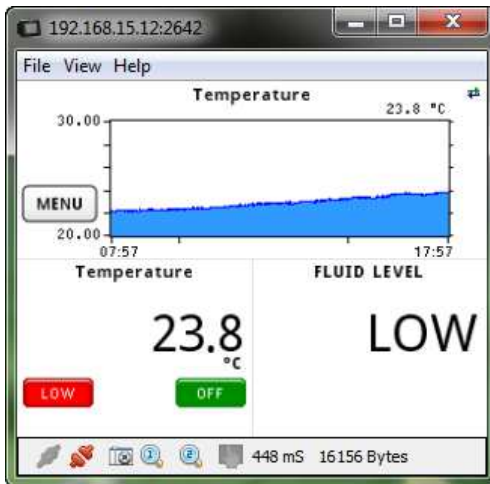

Figure 20-5 *SmartVue Remote* displaying a remote screen

21.0 Appendix

21.1 Mechanical Drawings

This section contains dimensional drawings and panel cutout dimensions for mounting the SmartVue to a panel.

Panel Mounting Kit: Phillips Pan Head screws with washers for panel mounting (for various panel thicknesses): 6-32 × 1/2" screws (4), 6-32 × 5/8" screws (4), 6-32 × 3/4" screws (4).

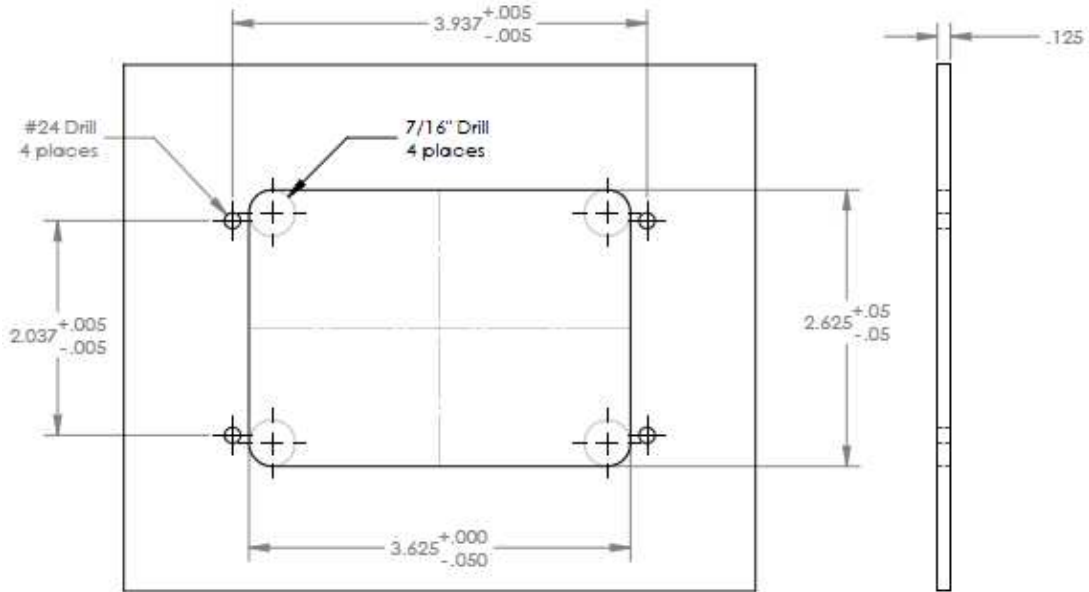

Figure 21-1 Panel mounting cutout dimensions

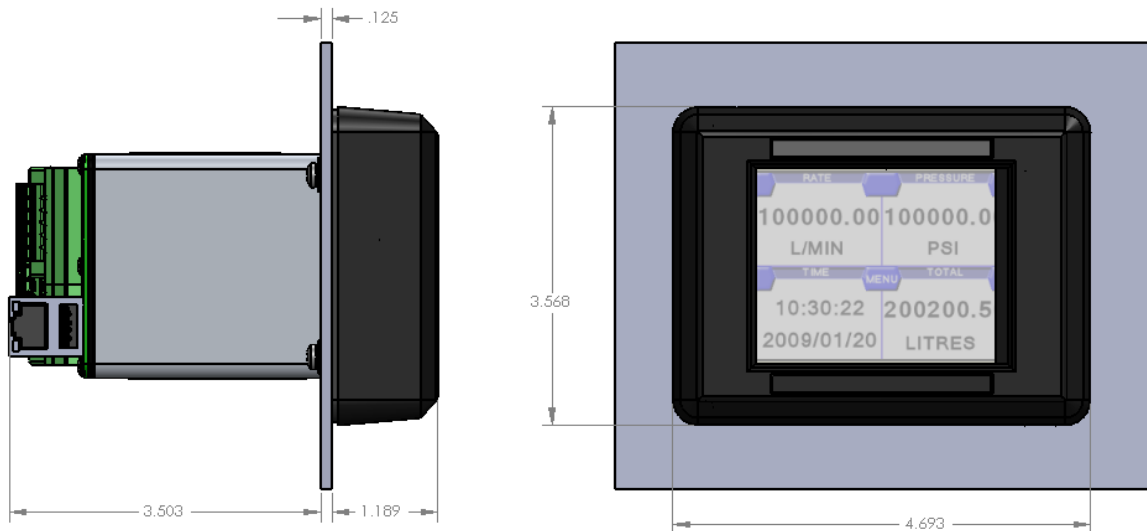

Figure 21-2 SmartVue dimensions

21.2 Panel Mounting the SmartVue

The SmartVue is designed and manufactured to maintain a NEMA 4 compatible rating when properly installed into a NEMA 4 or higher rated enclosure. Mounting is simple and requires only the supplied gasket and a #2 Philips screwdriver.

➤ To install the SmartVue

1. Prepare the installation location with the panel cutout. Please refer to Figure 21-1 for panel cutout dimensions.
2. Ensure that the gasket is in place behind the bezel.
3. Insert the SmartVue through the panel cutout, as shown in Figure 21-3.

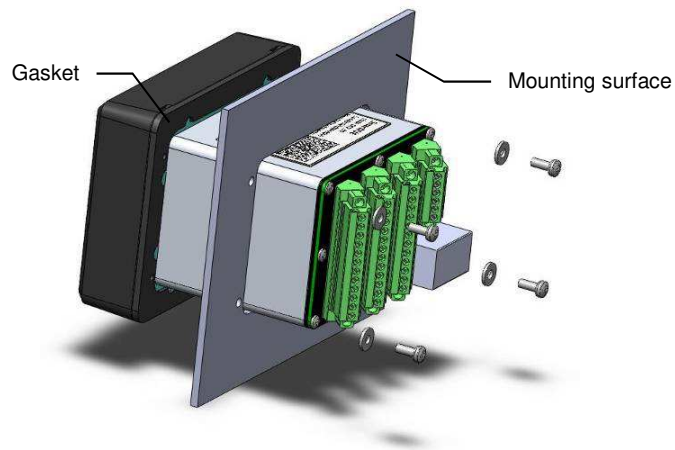

Figure 21-3 SmartVue installation – exploded view

4. Secure the SmartVue using the supplied screws and washers, as shown in Figure 21-4. A mounting kit with three sets of different length screws is supplied for installation into panels of varying thickness.

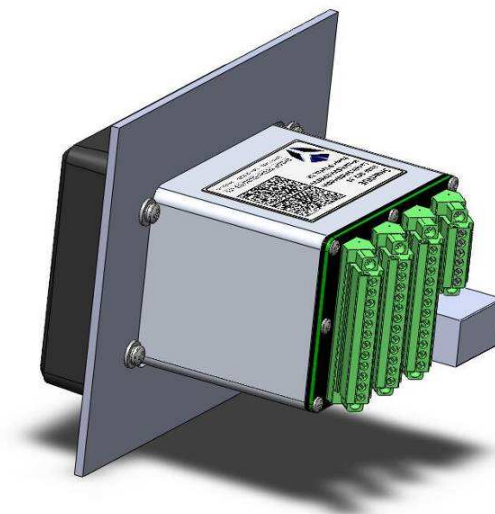

Figure 21-4 SmartVue installed in panel

21.3 Power and Signal Connections

Power and input/output connections are made through four removable terminal blocks on the back of the SmartVue (Figure 21-5). The terminal assignments are listed in Table 21-1.

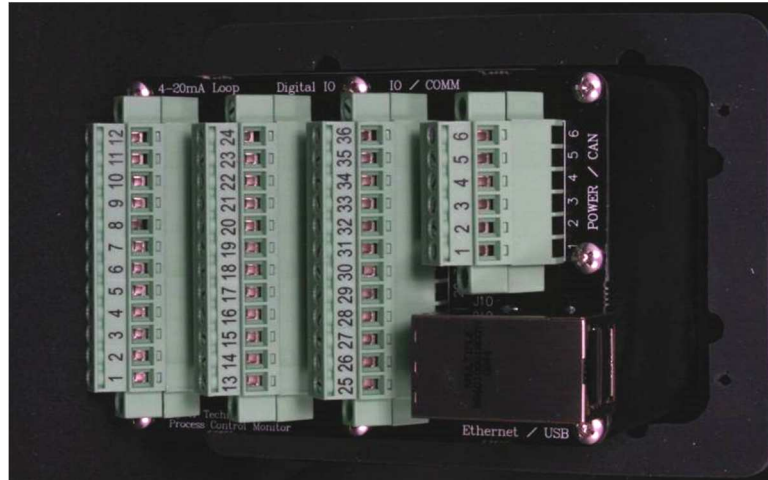

Figure 21-5 Rear view of the SmartVue with terminal block layout

Each terminal block can be removed without having to disconnect any wires that may already be secured to the terminals. To remove a terminal block use a small slotted screwdriver to loosen the two screws on both ends, then pull the connector socket away from the terminal pins.

Table 21-1 SmartVue Terminal Block Pinout

Connector	Terminal	Label	Description
J1	1	0-10V OUT 2	0-10 V output 2 (100Ω, 10 mA max.)
	2	0-10V OUT 1	0-10 V output 1 (100Ω, 10 mA max.)
	3	ISOLATED 24V -	24 V supply (negative)
	4	ISOLATED 24V +	24 V supply (positive)
	5	4-20mA OUT 2-	14-bit analog isolated output 2 (negative)
	6	4-20mA OUT 2+	14-bit analog isolated output 2 (positive)
	7	4-20mA OUT 1-	14-bit analog isolated output 1 (negative)
	8	4-20mA OUT 1+	14-bit analog isolated output 1 (positive)
	9	4-20mA IN 2-	16-bit analog input 2 (negative)
	10	4-20mA IN 2+	16-bit analog input 2 (positive)
	11	4-20mA IN 1-	16-bit analog input 1 (negative)
	12	4-20mA IN 1+	16-bit analog input 1 (positive)

Connector	Terminal	Label	Description
J2	13	RTD SNS / TH* / TC+*	RTD sense, thermistor, thermocouple (positive)
	14	RTD EXC	RTD excitation
	15	RTD GND / TH* / TC-*	RTD ground, thermistor, thermocouple (negative)
	16	DIO6 / VIN 6	Digital input/output 6, Analog input 6
	17	DIO5 / VIN 5	Digital input/output 5, Analog input 5
	18	DIO4 / VIN 4	Digital input/output 4, Analog input 4
	19	DIO3 / VIN 3	Digital input/output 3, Analog input 3
	20	DIO2 / VIN 2	Digital input/output 2, Analog input 2
	21	DIO1 / VIN 1	Digital input/output 1, Analog input 1
	22	GND	Ground
	23	FRQ OUT 2	Frequency output 2
	24	FRQ OUT 1	Frequency output 1
J3	25	TACH IN 2	Tachometer input 2
	26	TACH IN 1	Tachometer input 1
	27	GND	Ground
	28	QENC2-A / CTR1	Quadrature counter 2 input A, Hardware counter 1
	29	QENC2-B / CTR2	Quadrature counter 2 input B, Hardware counter 2
	30	QENC1-A / CTR3	Quadrature counter 1 input A, Hardware counter 3
	31	QENC1-B	Quadrature counter 1 input B
	32	GND	Ground
	33	RS232-RX	RS-232 receive
	34	RS232-TX	RS-232 transmit
	35	RS485 -	RS-485 inverting
	36	RS485 +	RS-485 non-inverting

Connector	Terminal	Label	Description
J4	1	10..30 VDC INPUT	DC Voltage In: Positive (10 to 30 VDC)
	2	PWR GND	DC Voltage In: Ground
	3	EARTH	Earth/chassis ground
	4	GND	Ground
	5*	CAN-H	CAN-bus dominant high
	6*	CAN-L	CAN-bus dominant low

21.4 Modbus Register Mapping

21.4.1 Discrete Inputs (Function Code 2 - Read Only bit)

SmartVue I/O Registers (Fixed Mapping)				
Discrete Inputs (Function Code 2 - Read Only bit)				
Address	Register	Modcon	TAG	Name
0	1	1	DIV1	Digital Input Valid
1	2	2	DIV2	Digital Input Valid
2	3	3	DIV3	Digital Input Valid
3	4	4	DIV4	Digital Input Valid
4	5	5	DIV5	Digital Input Valid
5	6	6	DIV6	Digital Input Valid
				Unused
				Unused
8	9	9	DOV1	Digital Output Valid
9	10	10	DOV2	Digital Output Valid
10	11	11	DOV3	Digital Output Valid
11	12	12	DOV4	Digital Output Valid
12	13	13	DOV5	Digital Output Valid
13	14	14	DOV6	Digital Output Valid
				Unused
				Unused
16	17	17	DI1	Digital Input
17	18	18	DI2	Digital Input
18	19	19	DI3	Digital Input
19	20	20	DI4	Digital Input
20	21	21	DI5	Digital Input
21	22	22	DI6	Digital Input
				Unused
				Unused
24	25	25	DO1	Digital Output
25	26	26	DO2	Digital Output
26	27	27	DO3	Digital Output
27	28	28	DO4	Digital Output
28	29	29	DO5	Digital Output
29	30	30	DO6	Digital Output

21.4.2 Input Register (Function Code 4 – Read Only 16-bit)

SmartVue I/O Registers (Fixed Mapping)						
Input Register (Function Code 4 - Read Only 16-bit)						
Address	Register	Modcon	TAG	Name	Data Type	
0	1	30001	SN_H	Serial Number	16-bit Integer	
1	2	30002	SN_L	Serial Number	16-bit Integer	
2	3	30003	YYYY	Year	16-bit Integer	
3	4	30004	MM	Month	16-bit Integer	
4	5	30005	DD	Day	16-bit Integer	
5	6	30006	HH	Hours	16-bit Integer	
6	7	30007	MM	Minutes	16-bit Integer	
7	8	30008	SS	Seconds	16-bit Integer	
8	9	30009	DOW	Day of Week	16-bit Integer	
9	10	30010	MDIM	Monitor Data Input Mask HW	32-bit Integer	
11	12	30012	MDOM	Monitor Data Output Mask	16-bit Integer	
12	13	30013	TEMPSS	Temperature Sensor Status	16-bit Integer	
13	14	30014	TEMP	Temperature	32-bit Float	°C
15	16	30016	TACH1	Tachometer Rate 1	32-bit Signed Integer	Hz
17	18	30018	TACH2	Tachometer Rate 2	32-bit Signed Integer	Hz
19	20	30020	CTR1	Counter Rate 1	32-bit Signed Integer	Hz
21	22	30022	CTR2	Counter Rate 2	32-bit Signed Integer	Hz
23	24	30024	CTR3	Counter Rate 3	32-bit Signed Integer	Hz
25	26	30026	QUAD1	Quadrature Rate 1	32-bit Signed Integer	Hz
27	28	30028	QUAD2	Quadrature Rate 2	32-bit Signed Integer	Hz
29	30	30030	CLI1	Current Loop In 1	32-bit Float	mA
31	32	30032	CLI2	Current Loop In 2	32-bit Float	mA
33	34	30034	VI1	Voltage In 1	32-bit Float	V
35	36	30036	VI2	Voltage In 2	32-bit Float	V
37	38	30038	VI3	Voltage In 3	32-bit Float	V
39	40	30040	VI4	Voltage In 4	32-bit Float	V
41	42	30042	VI5	Voltage In 5	32-bit Float	V
43	44	30044	VI6	Voltage In 6	32-bit Float	V
45	46	30046	DI1-6	Digital Inputs 1-6	16-bit Integer	
46	47	30047	CLO1	Current Loop Out 1	32-bit Float	mA
48	49	30049	CLO2	Current Loop Out 2	32-bit Float	mA
50	51	30051	VO1	Voltage Out 1	32-bit Float	V
52	53	30053	VO2	Voltage Out 2	32-bit Float	V
54	55	30055	FO1	Frequency Out 1	32-bit Float	Hz
56	57	30057	FO2	Frequency Out 2	32-bit Float	Hz
58	59	30059	DO1-6	Digital Outputs 1-6	16-bit Integer	

SmartVue I/O Registers (Fixed Mapping)						
Input Register (Function Code 4 - Read Only 16-bit)						
59	60	30060	STEMP	Scaled Temperature	Float	User Specified
61	62	30062	STACH1	Scaled Tachometer Rate 1	Float	User Specified
63	64	30064	STACH2	Scaled Tachometer Rate 2	Float	User Specified
65	66	30066	SCTR1	Scaled Counter Rate 1	Float	User Specified
67	68	30068	SCTR2	Scaled Counter Rate 2	Float	User Specified
69	70	30070	SCTR3	Scaled Counter Rate 3	Float	User Specified
71	72	30072	SQUAD1	Scaled Quadrature Rate 1	Float	User Specified
73	74	30074	SQUAD2	Scaled Quadrature Rate 2	Float	User Specified
75	76	30076	SCLI1	Scaled Current Loop In 1	Float	User Specified
77	78	30078	SCLI2	Scaled Current Loop In 2	Float	User Specified
79	80	30080	SVI1	Scaled Voltage In 1	Float	User Specified
81	82	30082	SVI2	Scaled Voltage In 2	Float	User Specified
83	84	30084	SVI3	Scaled Voltage In 3	Float	User Specified
85	86	30086	SVI4	Scaled Voltage In 4	Float	User Specified
87	88	30088	SVI5	Scaled Voltage In 5	Float	User Specified
89	90	30090	SVI6	Scaled Voltage In 6	Float	User Specified
91	92	30092	SCLO1	Scaled Current Loop Out 1	Float	User Specified
93	94	30094	SCLO2	Scaled Current Loop Out 2	Float	User Specified
95	96	30096	SVO1	Scaled Voltage Out 1	Float	User Specified
97	98	30098	SVO2	Scaled Voltage Out 2	Float	User Specified
99	100	30100	SFO1	Scaled Frequency Out 1	Float	User Specified
101	102	30102	SFO2	Scaled Frequency Out 2	Float	User Specified

21.4.3 Input Register (Function Code 4)

Process/Control Registers (User Configurable Mapping)					
Input Register (Function Code 4)					
Address	Register ID	Modcon	Process/Control (User)	Variable (User)	Reg Type (Auto)
200	201	30201	Process 1 (Pump Ctrl)	1 - Rate (RPM)	32 Float
202	203	30203	Process 2	1 - DIN	32 Integer
204	205	30205	Process 3	1 - SPN State(Gear)	32 Integer
206	207	30207	Process 1 (Pump Ctrl)	2 - Total (Rotations)	32 Float
208	209	30209	Control 1 (Flow)	2- Feedback (Flow)	32 Float
210	211	30211	Process Status		
212	213	30213	Control Status		
214	215	30215	Control Multiplier		
216	217	30217			
218	219	30219		Process Status	
220	221	30221		Process Type + Process Error	
222	223	30223		0x10	Process Error (Input Error)
224	225	30225		0x0F	Process Type Field
226	227	30227			
228	229	30229		Control Status	
230	231	30231		Control Type + Control Error + SP Error + FB Error	
232	233	30233		0x40	FB Input Error
234	235	30235		0x20	SP Input Error
236	237	30237		0x10	Control Error (Control Loop Stopped)
238	239	30239		0x0F	Control Type Field
240	241	30241			
242	243	30243			
244	245	30245			
246	247	30247			
248	249	30249			
250	251	30251			
252	253	30253			
254	255	30255			
256	257	30257			
258	259	30259			
260	261	30261			
262	263	30263			

21.4.4 J1939 SPN Input Register (Function Code 4 - Read Only)

J1939 SPN Registers				
Input Register (Function Code 4 - Read Only)				
Address	Register ID	Modcon	Tag	Status/Data
1000	1001	31001	J1939STATUS	Status
1001	1002	31002	SPNSTATUS1	Status
1002	1003	31003	SPNDATA1	Data
1004	1005	31005	SPNSTATUS2	Status
1005	1006	31006	SPNDATA2	Data
1007	1008	31008	SPNSTATUS3	Status
1008	1009	31009	SPNDATA3	Data
1010	1011	31011	SPNSTATUS4	Status
1011	1012	31012	SPNDATA4	Data
1013	1014	31014	SPNSTATUS5	Status
1014	1015	31015	SPNDATA5	Data
1016	1017	31017	SPNSTATUS6	Status
1017	1018	31018	SPNDATA6	Data
1019	1020	31020	SPNSTATUS7	Status
1020	1021	31021	SPNDATA7	Data
1022	1023	31023	SPNSTATUS8	Status
1023	1024	31024	SPNDATA8	Data
1025	1026	31026	SPNSTATUS9	Status
1026	1027	31027	SPNDATA9	Data
1028	1029	31029	SPNSTATUS10	Status
1029	1030	31030	SPNDATA10	Data
1031	1032	31032	SPNSTATUS11	Status
1032	1033	31033	SPNDATA11	Data
1034	1035	31035	SPNSTATUS12	Status
1035	1036	31036	SPNDATA12	Data
1037	1038	31038	SPNSTATUS13	Status
1038	1039	31039	SPNDATA13	Data
1040	1041	31041	SPNSTATUS14	Status
1041	1042	31042	SPNDATA14	Data
1043	1044	31044	SPNSTATUS15	Status
1044	1045	31045	SPNDATA15	Data
1046	1047	31047	SPNSTATUS16	Status
1047	1048	31048	SPNDATA16	Data

Notes

- J1939 Stack Status: 0=disabled, 1=claiming, 2=claim_failed, 3=initialized, 4=running, 5=internal_OS_error
- SPN Status: bit0=nodata, bit1=timeout, bit2=over_range, bit3=under_range, bit4=stack_not_running, bit5=data_is_integer, bit6=disabled
- Data can be float or integer

21.4.5 J1939 DTC Input Register (Function Code 4 - Read Only 16-bit)

J1939 DTC Registers			
Input Register (Function Code 4 - Read Only 16-bit)			
Address	Register ID	Modcon	Data
1100	1101	31101	STATUS1
1101	1102	31102	ECU1
1102	1103	31103	LAMP1
1103	1104	31104	NCODES1
1104	1105	31105	DTC1-1_H
1105	1106	31106	DTC1-1_L
1106	1107	31107	FMI1-1
1107	1108	31108	OC1-1
1108	1109	31109	DTC1-2_H
1109	1110	31110	DTC1-2_L
1110	1111	31111	FMI1-2
1111	1112	31112	OC1-2
	
1140	1141	31141	DTC1-10_H
1141	1142	31142	DTC1-10_L
1142	1143	31143	FMI1-10
1143	1144	31144	OC1-10
	
1144	1145	31145	STATUS2
1145	1146	31146	ECU2
1146	1147	31147	LAMP2
1147	1148	31148	NCODES2
1148	1149	31149	DTC2-1_H
1149	1150	31150	DTC2-1_L
1150	1151	31151	FMI2-1
1151	1152	31152	OC2-1
1152	1153	31153	DTC2-2_H
1153	1154	31154	DTC2-2_L
	
1760	1761	31761	STATUS16
1761	1762	31762	ECU16
1762	1763	31763	NCODES16
1763	1764	31764	DTC16-1_H
1764	1765	31765	DTC16-1_L
1765	1766	31766	FMI16-1
1766	1767	31767	OC16-1
1767	1768	31768	DTC16-2_H
	
1803	1804	31804	OC16-10

Notes

- ECU STATUS: bit0=timeout, bit1=invalid, bit2=stack_not_running, bit3=disabled
- LAMP: Indicator Lamps
bit1: 0=Protect Lamp Status (SPN 987)
bit3: 2=Warning Lamp Status (SPN 624)
bit5: 4=Stop Lamp Status (SPN 623)
bit7: 6=MIL Status (SPN 1213)
bit9: 8=Flash Protect Lamp (SPN 3041)
bit11: 10=Flash Warning Lamp (SPN 3040)
bit13: 12=Flash Stop Lamp (SPN 3039)
bit15: 14=Flash MIL (SPN 3038)