

PD6310-WM / PD8-6310-WM

NTEP® Certified Pulse Input Batch Controllers



PROVU®
SERIES



SUPER-BRIGHT LEDs
Our Brightest Display Ever

MeterView Pro
USB Install



WEIGHTS & MEASURES

COMMON FEATURES

- Pulse, Open Collector, NPN, PNP, TTL, Switch Contact, Sine Wave (Coil), Square Wave Inputs
- Dual-Line 6-Digit Display, 0.60" & 0.46" Height
- Input Power Options Include 85-265 VAC or 12-24 VDC
- 5, 10, or 24 VDC Flowmeter Power Supply
- 2 or 4 Relays + Isolated 4-20 mA Output Options
- Modbus® RTU Communication Protocol Standard
- K-Factor, Internal Scaling, or External Calibration
- Onboard USB and MeterView® Pro Programming Software

PROVU® PANEL MOUNT FEATURES

- Standard 1/8 DIN Mounting
- NEMA 4X, IP65 Front
- Optional SunBright Display Models for Outdoor Applications

COMMON BATCH CONTROLLER FEATURES

- Single or Multi-Stage Batch Control
- Automatic or Manual Batch Control
- Start / Pause / Stop, Change Batch with Front Panel Buttons
- Automatic Overrun Correction
- Count Up or Down with Each Batch
- Display Batch Total, Rate, Grand Total, Count or Preset
- Rate in Units per Second, Minute, Hour, or Day
- 9 Digit Grand Total with Overflow Feature
- Low or High Flow Alarms while Batching

PROTEX EXPLOSION-PROOF FEATURES

- Explosion-Proof NEMA 4X, IP68
- Display Mountable in 90 Degree Increments
- SafeTouch® Through-Glass Programming
- Flanges for Wall or Pipe Mounting
- Rugged, Die-Cast Aluminum Enclosure
- SunBright Display Models Standard

PD6310-WM / PD8-6310-WM NTEP® Certified Batch Controllers



UV Resistant
Sunlight Readable Display



Front Panel
NEMA 4X Rated



INTRODUCTION

The PD6310-WM and PD8-6310-WM are NTEP® Certified, pulse input single or multi-stage batch controllers certified as Weighing and Measuring Devices. These versatile NTEP Certified batch controllers are not only ideal for Weights and Measures batching applications, but provide reliable, cost-effective, independent batch control operation where local control is preferred to expensive systems with a much larger footprint. The PD6310-WM is a panel mount NTEP Certified batch controller and the PD8-6310-WM is an explosion-proof NTEP Certified batch controller.

The specifications and operation of the panel mount and explosion-proof versions of these batch controllers is very much the same. The main difference is the rating of the flowmeter power supply. These batch controllers have a mechanically secured, tamper-proof, programming lockout feature that consists of a cable with a compression seal that is used to prevent access to the programming lockout jumper.

**NTEP®
Certified Wire
Security Seal**
**Prevents access to
the programming
lockout jumper**

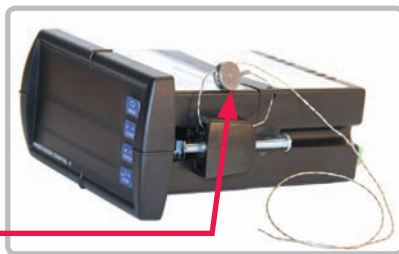

Programming and operating these batch controllers is via front panel start, pause, stop, and batch size buttons. As an added benefit, The PD8-6310 explosion-proof batch controller's Safe-Touch buttons allow it to be programmed without removing the cover, making it easy and economical to change batch sizes in the hazardous area.

The high intensity, sunlight readable, dual line display makes it possible to locate these batch controllers outdoors in direct sunlight and display a variety of useful information. For instance the upper display could show the running batch total and the lower display could show the batch size.

Free MeterView PC-based software allows these batch controllers to be programmed and operated via a computer.

INTUITIVE BATCH CONTROL

The front panel has intuitive buttons and displays that make operating the batch controller clear and easy right out of the box. START, BATCH, and STOP buttons come setup by default for batch controller operation. The START button is used to begin a batching process. The BATCH button is used to quickly access the preset value. The STOP button can be pressed once to pause a batch, or twice to cancel a batch in progress. The upper and lower displays can be easily configured for your application need. The STOP button may be used to easily cycle the lower display information while the batch is stopped.

Easily Choose Your Display Information



Batch Total & Preset

The preset on the lower display provides even quicker access to the preset menu just by using the arrow keys to change the value.



Batch Total & Rate

The rate on the lower display may be alternated with units for variable flow batching systems. Rate alarms may also be used during the batch process.



Batch Total & Batch Count

The batch count on the lower display, tracks completed batches. The count may be set back to 0 with the reset menu.



Batch Total & Grand Total

A grand total with overflow digits for up to a 9 digit total may be displayed in the lower display, with password protection and non-resettable programmable features.

Clearly Labeled Alternating Displays



Batch Total & Preset

Alternating Display

The upper display alternates the display to show the batch controller state when in pause or stop mode. When displaying rate, grand total, batch count, or preset, the lower display alternates between the display value and the function or unit of measure.

Grand Total Displays Up to 9 Digits

These batch controllers can display up to nine digits of total flow with the grand total feature. In the diagrams below, the batch controller is displaying 532,831,470 by toggling between a display



of "oF 532" and "831470". Notice the (GT with arrow ▲ symbol) is lit up indicating the display is in a grand total overflow mode.

K-Factor Calibration



Input Setup

Display Setup

The PROVu batch controller may be calibrated using the K-Factor function. The batch controller will automatically calculate the flow rate using the K-Factor (usually supplied by the flowmeter manufacturer) and the time base selected.

BATCH CONTROLLER CAPABILITIES

An NTEP Certified batch controller can be programmed for a wide variety of applications. Setup is easy for single or multi-stage batching. Automatic overrun correction keeps the batch size accurate, even over time and with system wear. It can record grand total, or non-resettable grand total with a time base of seconds, minutes, hours or days. The user can program a conversion factor, and configure a non-resettable grand total, and password protection.

Single and Multi-Stage Batching

The unit can be used as a single or multi-stage batch controller. Relays assigned to the total act as batch control relays, with

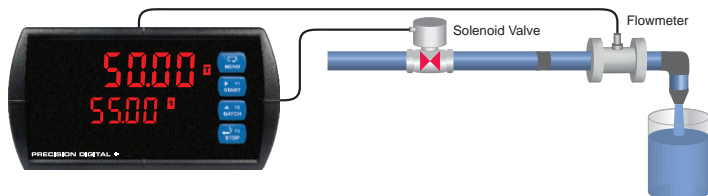

Single Stage Batch Control

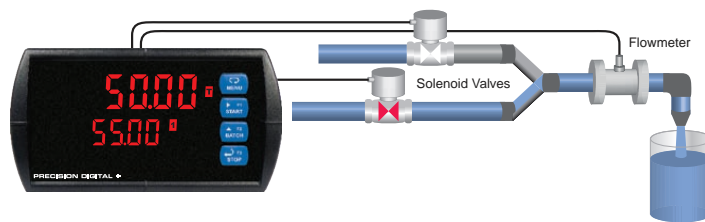

Multi-Stage Batch Control

additional relays beyond the first including a preclose value. The preclose deactivates the relay before the batch is finished, to allow slower fill rates and a more accurate batch finish. With expansion module relays, up to eight-stage batching is possible. Each additional stage batching relay has an individually programmable preclose amount.

Manual or Automatic Batch Control

Batches may be started manually with the START front panel button, or with a remote digital input trigger. Batches may also be programmed to start automatically after a 0 to 999.9 second delay after the end of the last completed batch. A manually stopped batch will not automatically restart. The START button or digital input must be used.

Automatic Overrun Correction

The NTEP Certified batch controller will correct for batch overrun or shortages automatically. By tracking the amount the batch was off by, the batch controller will automatically adjust the batch by modifying the batch relay deactivation time.

Quick Preset Changes



The front panel BATCH key is configured by default to access the preset menu. The preset may be changed quickly and easily between batches without the need to enter setup menus.

Non-Resettable Grand Total

The user can set up the grand total to be non-resettable by entering a specific password. Once this is done, the grand total can never be reset.

Total Conversion Factor

The user can enter a conversion factor that allows the batch controller to display total in different units than the rate. For instance, an operator could measure flow rate in gallons per minute and grand total in hundredths of acre-feet.

Grand Total & Rate Alarms

The unit's four internal and four external relays can be set up to alarm when the grand total reaches a user-defined set point or when the rate is above or below a certain value. Rate alarms are only activated when the batching process is running. A variety of reset modes are available and the user can also program time delays and fail-safe operation.

On-Board Digital Input for Remote Operation

The NTEP Certified batch controller includes a digital input as standard. This digital input, labeled F4, can be used for remote operations such as resetting the total. The digital input can operate with the interlock relays feature, force relays on from a signal from a PLC or relay on other equipment, display Max or Min flow rates, and much more. This is ideal for installations where the meter is inaccessible behind a cover, or where an additional function key is needed for customized operation.

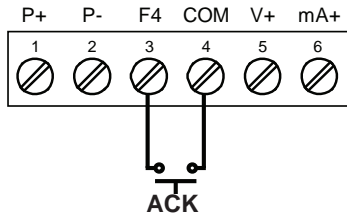

Rounding

The rounding feature is used to give the user a steadier display with fluctuating signals. It causes the display to round to the nearest value according to the rounding value selected (1, 2, 5, 10, 20, 50, or 100). For example, with a rounding value of 10, and a input of 12346, the display would indicate 12350.

Standard SunBright LED Display

The ProVu PD6310-WM and ProtEX-MAX PD8-6310-WM include a SunBright display that features extraordinarily bright LEDs. They are perfect for indoor and outdoor applications where visibility may be impaired by smoke, fog, dust, or distance or even in direct sunlight.

Four Types of Password Protection

The NTEP Certified batch controller offers 4 types of password protection. Level 1 protection allows the operator use of only the 3 pre-configured function keys on the front panel without a password. Level 2 protection allows the operator use of only the function keys and the ability to change set points without a password. Level 3 protection restricts the function keys and all configuration menus without a password. Finally, Grand Total Reset Protection prevents the total from being reset manually.

Rugged, Impact-Tested Front Panel

A unique front panel design makes the batch controller nearly impenetrable in typical applications. The NTEP Certified batch controller easily survives a direct hit on the display from a heavy 2" solid stainless steel ball dropped from a height of eight feet.

OUTPUTS

Relay Outputs

The batch controller has up to four 3 A Form C relays (SPDT) with multiple programmable functions. One (relay 1) should always be used for batch control. Other relays may be configured as additional batch relays, with or without preclose for multi-stage batching or as alarms for the rate or grand total. Each alarm has multiple power loss fail-safe options. Alarm relays can be configured for proper protective action upon input loop break. Alarm relay ON and OFF delay times are user adjustable. Up to eight front panel indicators show alarm and/or relay state. All alarm relays can be configured for 0-100% deadband. Rate alarms are only active while a batch is running.

Relay Operation/Configuration

There are powerful relay functions that can be configured in the NTEP Certified batch controller, including:

- Single and multiple stage batch control with preclose
- Manual and automatic batch control modes
- Rate alarms during batch process
- Grand total alarms
- Sampling function
- User selectable fail-safe operation
- Time delay (on and off), independent for each alarm relay

Analog Output

The isolated analog retransmission signal can be configured to represent the batch total, grand total, maximum (peak) value, minimum (valley) value, the value for any of the eight relay set points, manual setting control, or Modbus input. While the output is nominally 4-20 mA, the signal will accurately accommodate under- and over-ranges from 1 to 23 mA.

Isolated Transmitter Power Supplies

A powerful 24 V @ 200 mA power supply is a standard feature on the ProVu® NTEP Certified batch controller; the PD8 model's power supply is rated at 25 mA max. It can be configured for 5, 10, or 24 V (default) by means of a simple internal jumper. An additional power supply (for ProVu=24V @ 40mA; for ProtEX=24V @ 25mA) is standard with the 4-20 mA output option.

DIGITAL COMMUNICATIONS

Modbus® RTU Serial Communications

NTEP Certified batch controllers can communicate with any Modbus Master device using Modbus communications protocol. RS-485 connections come standard on the PD8; the PD6310-WM models require the purchase of a serial communication adapter. Below are some examples of other things that can be done with the unit's Modbus communications feature.

- Start, pause, stop, or change preset values
- Send a 6-character message to the lower display upon an event
- Remote user control (i.e. change set points, acknowledge alarms)
- Read rate, total, grand total, batch count, etc.



Modbus PV Input



Remote Message

FIELD EXPANSION MODULES

Add functionality to the PD6310-WM ProVu NTEP Certified batch controller in the field with easy-to-install external expansion modules. Add USB, RS-232, or RS-485 communications, I/O modules, and 4-relay expansion module. **Note:** Not compatible with PD8 models.

MANUAL MULTI-STAGE BATCH CONTROL OPERATION

System Setup

Both valves are closed with an empty barrel in place. The batch total is displayed in the upper display, the preset is selected for the lower display.

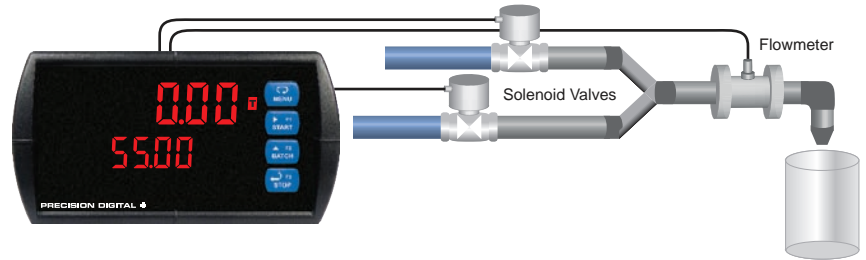

Batch Start

The START button is pressed. Both valves open. The barrel begins to fill.

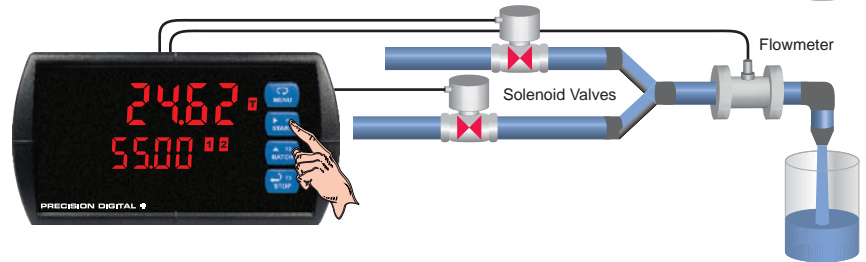

Preclose Valve

When the batch total reaches a value of 50.00 (Preset [55.00] – Preclose [5.00]) the full-flow valve closes. The fill rate of the tank slows as a result.

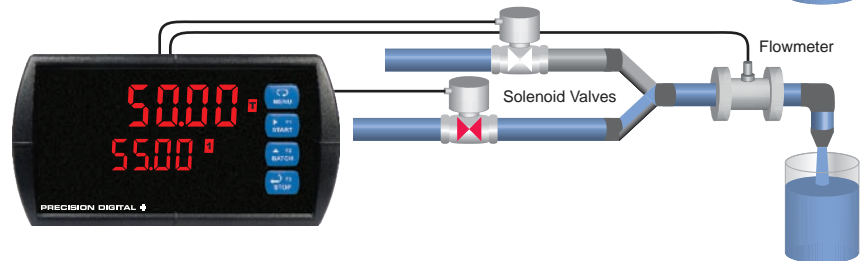

Completed Batch

When the batch total equals the preset amount, the restricted-flow valve closes. The barrel is now full. If some overrun occurs, the next batch will adjust for this offset amount to maintain accuracy.

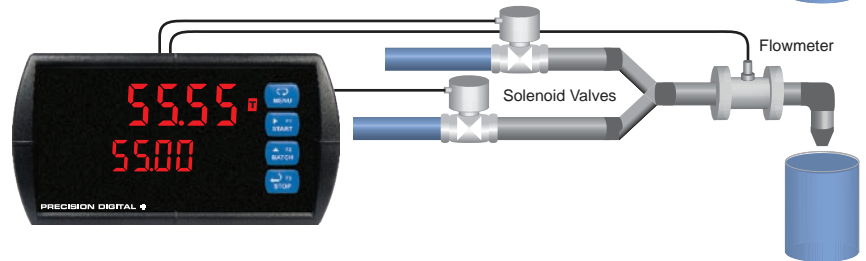

Change Preset

After placing a new, empty barrel, a new preset fill amount may be selected with the Batch key, while the process is stopped.

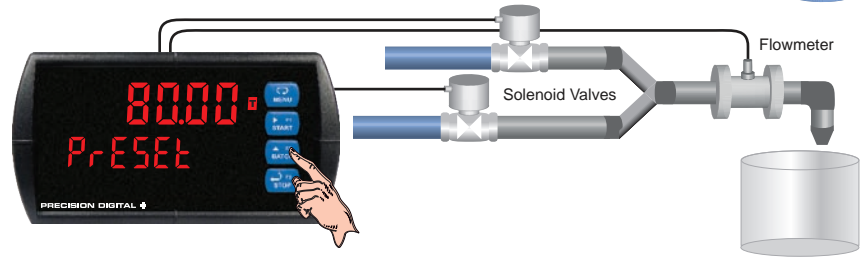

Begin New Batch

Press the START key and a new batch will begin. With both valves open, the process continues.

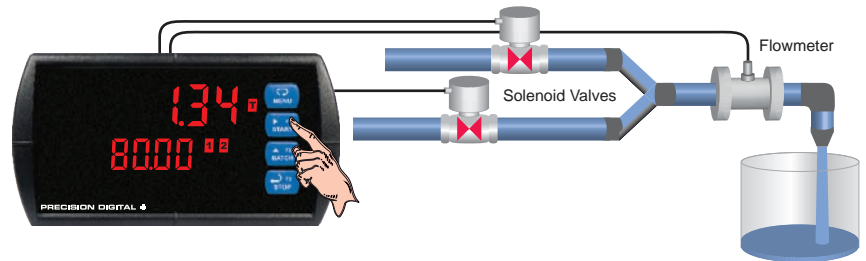

Pause/Stop

At any time, the STOP button may be pressed, once to Pause the process, or twice to cancel the batch, which stops the process.

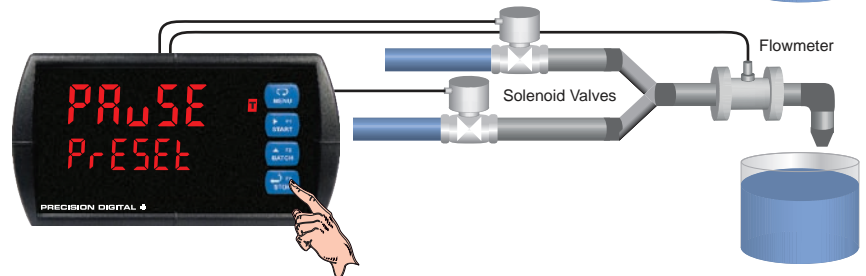

PD8-6310-WM OVERVIEW

The explosion-proof NTEP Certified batch controller (PD8-6310-WM) has been designed to offer the functions and features of the PROVU PD6310-WM in a durable, fully approved explosion-proof product. The PD8-6310-WM is not just an 1/8 DIN meter mounted in an explosion-proof housing. A special bezel and electronics were designed exclusively for the PD8-6310-WM. The bezel and faceplate house the additional electronics for the PD8. The PD8's interior case is secured with an NTEP Certified wire seal. The PD8's explosion-proof display is rotatable in 90 degree increments to ensure information remains visible in any mounting configuration.

Program Batch Controller without Removing the Cover

The ProtEX explosion-proof NTEP Certified PD8-6310-WM Batch Controller is equipped with four infrared sensors that operate as through-glass buttons so that it can be programmed and operated without removing the cover in a hazardous area, keeping the electronics protected and secure. These SafeTouch® buttons can be disabled for security by selecting the LOCK setting on the switch, located on the connector board in the base of the enclosure. To actuate a button, press one finger to the glass directly over the marked button area. When the cover is removed, the mechanical buttons located on the faceplate can be used. PD8-6310-WM models with integrated PROVU functionality have a 10-position terminal block for connecting the digital inputs and outputs. See the PD8 Connection Drawing on page 9.



Durable, Reliable and Practical Enclosure

The first thing customers notice about a product is its enclosure and the explosion-proof PD8 really stands alone. The copper-free (0.30%), smooth, die-cast aluminum NEMA 4X (IP68) enclosure is finished with a corrosion resistant epoxy coating that protects the PD8-6310-WM from the harshest environments. The built-in mounting flanges make for convenient wall or pipe mounting and there is even a slot on the back of the enclosure for centering on the pipe. There are four 3/4" NPT conduit holes for wiring.

Pre-Installed Conduit/Stopping Plug

The PD8-6310-WM is supplied with two pre-installed conduit plugs for installations that do not require the use of all conduit entries. The conduit/stopping plugs include an internal 12mm hexagonal socket recess for removal.

Wire Security Seal Installation

Installation of the NTEP Seal requires removal of the cover of the PD8 enclosure. Using a M2 hex wrench, turn the cover jam screw counter-clockwise until the screw is out of the aluminum enclosure enough to remove the cover. Once the cover is removed from the enclosure, remove the faceplate and guts of the meter. Unscrew the rear interior case and connect the NTEP jumper as shown in **Figure 1** on the back page, then fasten the interior case. To install the NTEP Seal on the PD8-6310-WM, simply pass the wire security loop through the pass through holes on both sections of the cover of the interior casing. Pass the wire loop back through the crimp seal end and tighten. The wire loop may now be tagged, crimped, and sealed to mechanically secure the enclosure and prevent access to the NTEP lockout jumper.

Connections

To access the connectors, remove the enclosure cover and unscrew the two captive screws that fasten the electronics module. Signal connections are made to de-pluggable connectors on the back of the electronics module. Some connectors may be provided already connected. These connections are required for proper operation of the ProtEX-MAX, and should not be removed unless instructed. Wires marked as being used for testing purposes should be removed. Grounding connections are made to the two ground screws provided on the base - one internal and one external. After all connections have been completed and verified, apply power to the unit.

Remote Operation of the Batch Controller

The PD8-6310-WM includes 4 digital inputs. These digital inputs are preconfigured at the factory to function as external contacts to duplicate the front button functions of the instrument. The factory configuration uses the following corresponding digital input terminals for external switch contacts.

- I1=MENU
- I2=RIGHT Arrow=START
- I3=UP Arrow=BATCH
- I4=ENTER Arrow=STOP

These contacts can be wired up to a remote Control Station to handle programming and to operate the batch controller remotely such as the control button station shown on the right.



Rotatable Display

The PD8-6310-WM's display can be rotated in 90 degree increments so you don't have to read critical information upside down or sideways. The built-in mounting flanges make for convenient wall or pipe mounting and there is even a slot on the back of the enclosure for centering on the pipe. There are four 3/4" NPT conduit holes for wiring (two metal conduit plugs supplied).



Digital I/O

The explosion-proof NTEP Certified batch controller has four digital inputs (I1-I4) and four digital outputs (O1-O4) standard.

The four digital inputs can function similarly to the front panel function keys, and are activated by a closed contact, transistor closure, logic level signal, or with the SafeTouch Through-Glass Buttons. They are configured at the factory to allow through-glass or remote control of the batch controller.

Digital outputs can be used to monitor alarm conditions, indicate relay alarm acknowledgement, or mimic the batching relay states for remote indication of the batching relay states.

METERVIEW® PRO SOFTWARE

Free USB Programming Software & Cable

The PROVU and ProtEX-MAX™ Batch Controllers come preloaded with free MeterView® Pro programming software that connects and installs directly to your PC with a standard USB cable, also provided free with each instrument. This eliminates the need to insert CDs, install drivers, or download software from the internet. The software will allow you to configure, monitor, and datalog a PD6310-WM OR PD8-6310-WM using your PC. Just simply connect the batch controller to your PC with the USB cable and within minutes you will be programming it.

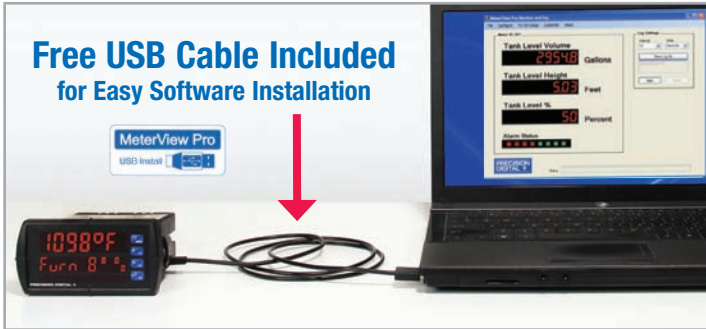

MeterView Pro makes complete meter configuration simple and fast. MVP's linearization feature makes even a 32-point linearization task clear and easy to do. We also included a basic meter monitor and datalogger. Of course, with the batch controller's powerful Modbus protocol, custom programs can be made even more versatile.

Fully Program the Batch Controller

All the programming parameters of the batch controller may be configured from MeterView Pro Software. The configuration file may be saved for later use, and saved configuration files may be loaded into the software for download into the Batch Controller.

Communications Setup

For initial communications setup of MeterView Pro, simply select the meter type, by model (i.e. PD6310), and make sure that the communication port on the computer is ready, indicated by the status box. To set up the communication port, click PC Port Setup at the top of the window, which will bring the user to the MeterView Serial Setup window. The operator plugs the data into the appropriate boxes via drop-down menus for Com Port, Meter Address, Baud Rate, and Parity.

Note: Baud Rate and Parity must match with those of other devices when using Modbus, otherwise communication breaks may occur.

Setup

Within the main/configure window of MeterView Pro, select the Setup Tab to select the Input Type and Decimal Point, as well as enable/disable total/grand total flow measurement. Display parameters for Upper and Lower Displays, such as engineering units, are entered here, along with a display intensity value (8 being the brightest setting). Analog Outputs are scaled and tested here as well, using both display values and output values to translate the 4-20 mA signal. Relays can be set to force on, or set for automatic operation.

Communications Setup

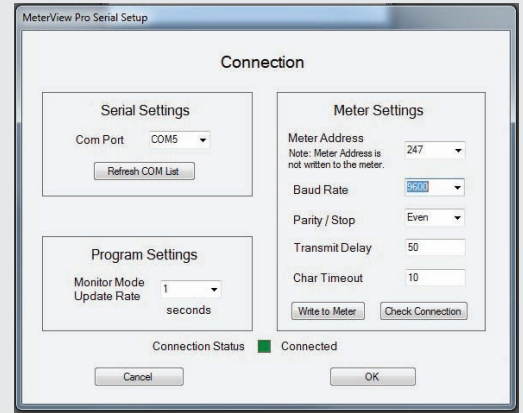

Setup

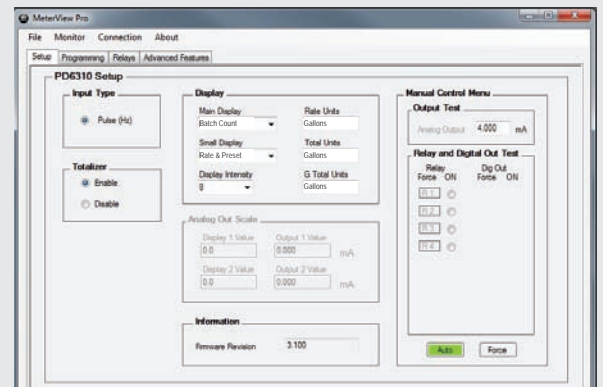

Relays

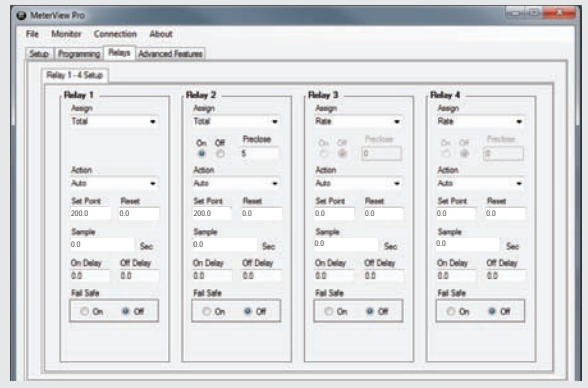

Batch Control From a Computer

Through MeterView Pro Software, the preset and relay 2 preclose may be easily changed from the main control window shown here. The total and grand total may be reset with just the click of a button. The batch controller may be started, paused, and stopped through the control window, for full featured batch controller operation.

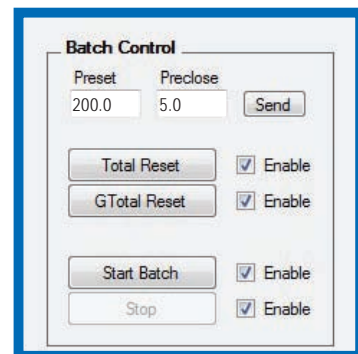

Relays

Use the Relays Tab in MeterView Pro to independently program each relay. Actions can be set for each relay, and certain parameters pertain to each selection. Sample time can be entered for batch sampling. Set and reset points, as well as delay times for each relay, can be entered for specific applications. Fail Safe can be enabled/disabled for each relay. Actions can also be set for Input Break conditions at this level.

Programming

Through MeterView Pro Software, operators can independently scale the meter's inputs using the Programming Tab. MeterView Pro contains a linearization feature that is helpful for flowmeters with non-linear outputs. First, enter the number of linearization (PV/Rate) points, from 1-32. Then, in the corresponding window for

Linearization Feature

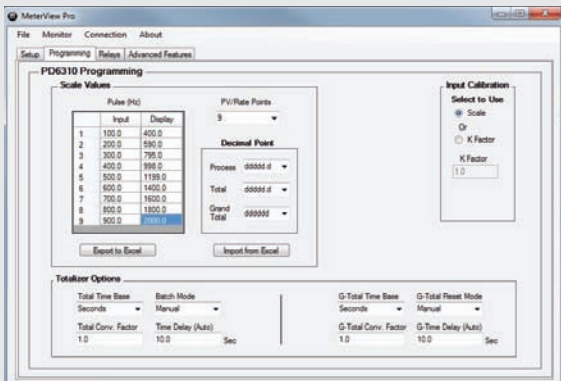

each input, enter both the input values and the display values for each of the points. Once the appropriate data has been entered, the meter will display the proper flow information. Linearization data can be exported to or imported from Microsoft Excel. This window is also used to program the K-Factor.

Advanced Features

Through the Advanced Features menu in MeterView Pro Software, the operator is able to program a variety of items pertaining to Inputs, Outputs, Function Keys, and General Operation. For all Function Keys and Digital Outputs, parameters are set under the User Menu for a number of variables, including Alarms, Acknowledgement, Set/Reset, and more.

Advanced Features

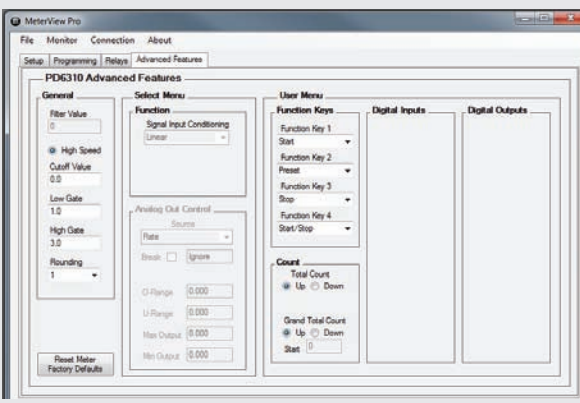

Monitor & Datalog

Once the operator has entered all the necessary data for programming, MeterView Pro enables full monitoring of the meter, accessed by clicking Monitor at the top toolbar. The example here depicts the monitoring of the Current Batch, Batch Preset (Size), and Overall Batch Total. Alarm Status is clearly indicated by the green and red blocks numbered for each relay. Log Settings are entered by Interval and Time Base Unit. Data Logging can be started and paused in this location. Through MeterView Pro Software, the user is able to save the datalog report to the computer's C:/ Drive using the "Save Log As" button. The log can be retrieved and/or printed at any time.

Monitor & Datalog

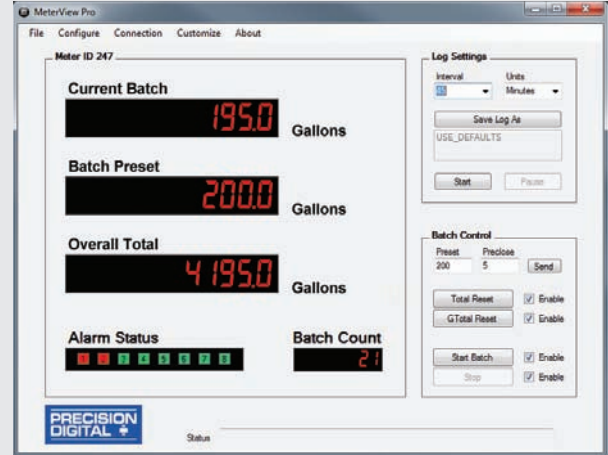

Relays

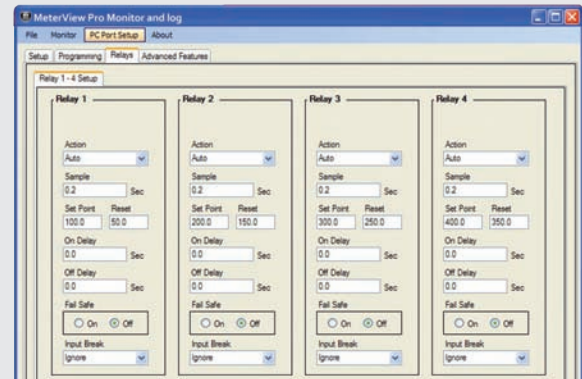

NEMA 4, NEMA 4X, AND EXPLOSION-PROOF ENCLOSURES

Thermoplastic and stainless steel NEMA 4X, and painted steel NEMA 4 enclosures are available. Also available is the ProtEX-MAX for hazardous area applications requiring explosion-proof enclosures. Visit our website at www.predig.com for more information.



PDA2600
Stainless Steel



PDA2811
Plastic Low-Cost



PD8 Series
ProtEX-MAX

PD8-6310-WM DIMENSIONS

Units: Inch (mm)

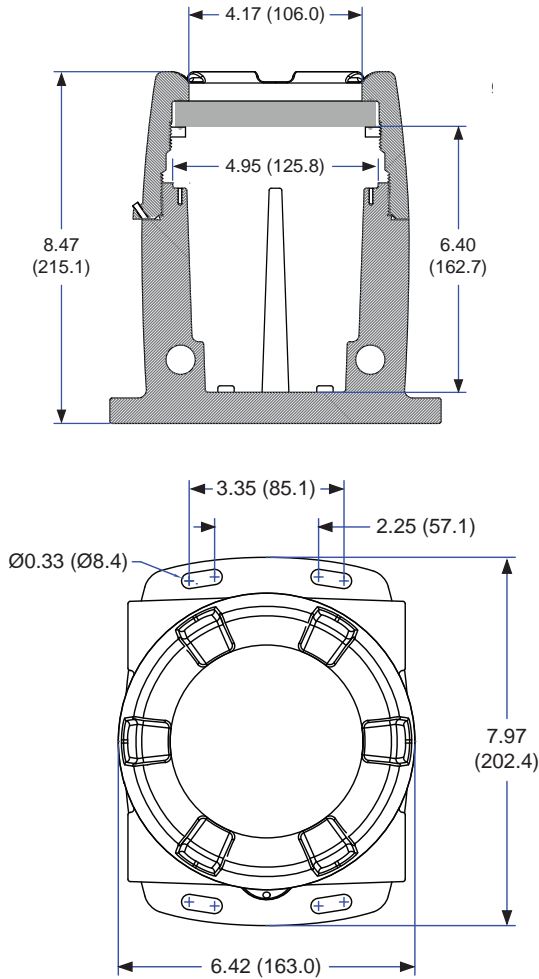

PD6310-WM DIMENSIONS

Units: Inch (mm)

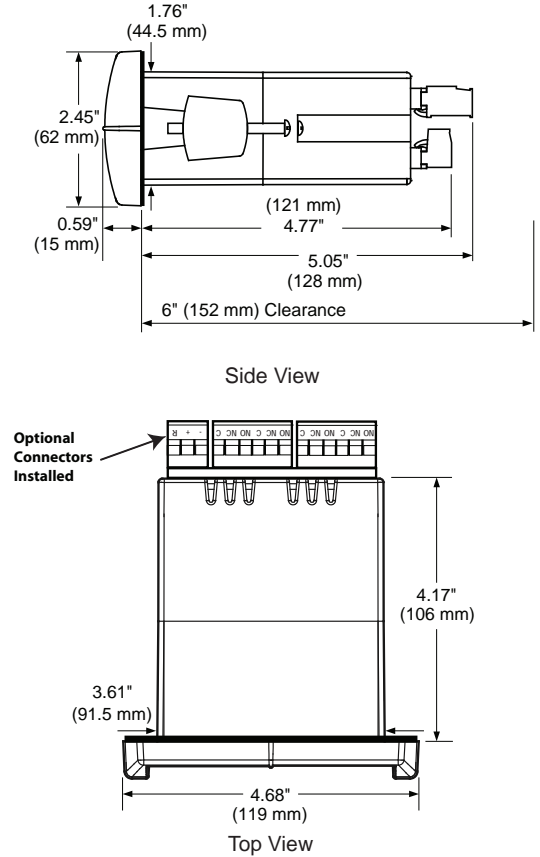

Notes:

1. Panel cutout required: 1.772" x 3.622" (45mm x 92mm)
2. Panel thickness: 0.040 - 0.250" (1.0mm - 6.4mm)
3. Mounting brackets lock in place for easy mounting
4. Clearance: Allow 6" (152 mm) behind the panel

CONNECTIONS

PD8-6310-WM Connection Drawing

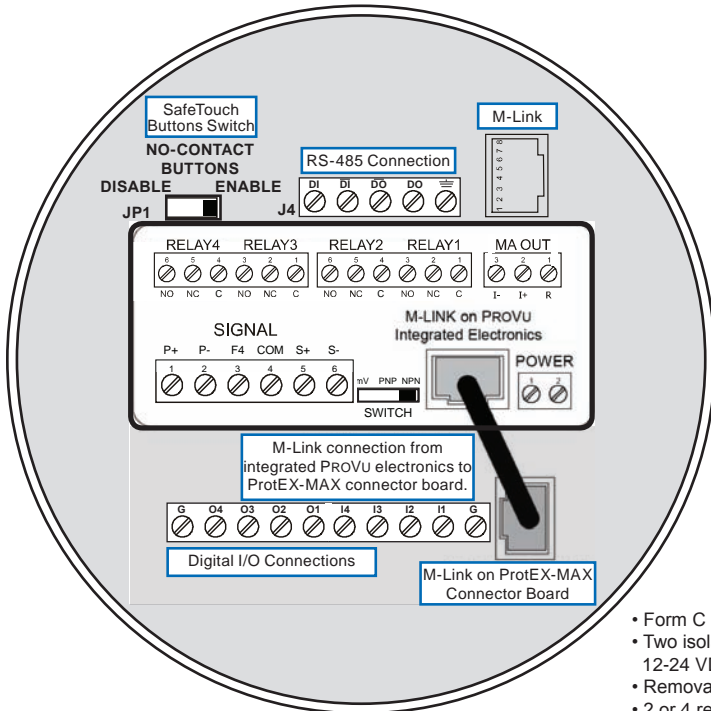

PD6310-WM Connection Drawing

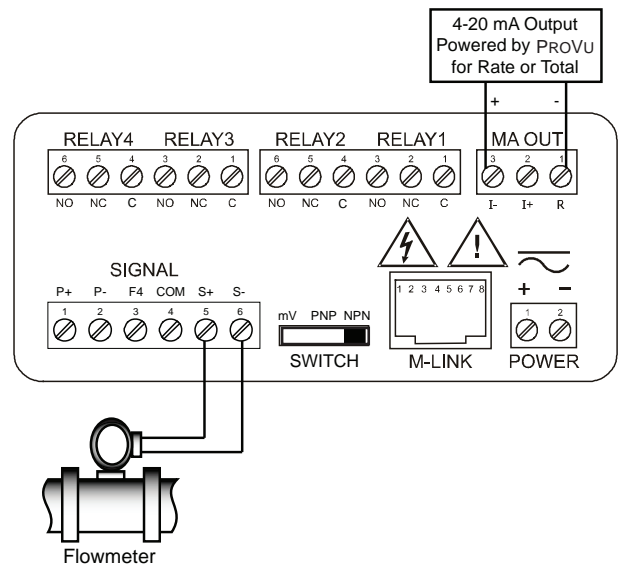

- Form C (SPDT) relays
- Two isolated power supplies available even on 12-24 VDC input power models
- Removable terminal blocks
- 2 or 4 relays + isolated 4-20 mA output option

- Input Power Options: 85-265 VAC or 12-24 VDC
- M-Link for adding expansion modules
- Digital Input (F4) is standard

SPECIFICATIONS

Except where noted all specifications apply to operation at +25°C.

General

Display: Upper display: 0.60" (15 mm) high. Lower display: 0.46" (12 mm) high. Both are 6 digits (-99999 to 999999), red LEDs, with lead zero blanking.

Default Display Assignment: The upper display shows batch total. The lower display shows rate with alternating units, and can be switched to show grand total, batch count, or preset with the STOP key.

Custom Display Assignment: The upper and lower displays may be assigned to rate, total, grand total, batch count, preset, set points, units (lower display only), alternating R & T, R & GT, preset & rate, max & min, or a Modbus display register. Any rate/total/grand total display may be programmed to alternate with a custom unit or tag.

Alternating Display: Displays alternate every 10 seconds when display is selected or the batch is paused.

Display Intensity: Eight user selectable intensity levels

Display Update Rate: 5/second (200 ms)

Overrange: Display flashes 999999

Underrange: Display flashes -99999

Operating Methods: Three programmable front panel buttons (default START, BATCH, STOP), digital inputs, PC and MeterView Pro software, and Modbus registers.

Programming Lockout: Programming lockout jumper. Seal loop and loop attachment features to prevent access to the lockout jumper.

F4 Digital Input Contacts: 3.3 VDC on contact. Connect normally open contacts across F4 to COM.

F4 Digital Input Logic Levels: Logic High: 3 to 5 VDC
Logic Low: 0 to 1.25 VDC

Noise Filter: Programmable from 2 to 199 (0 will disable filter)

Filter Bypass: Programmable from 0.1 to 99.9% of calibrated span.

Recalibration: Recommended at least every 12 months.

Max/Min Display: Max (Peak) / min (Valley) readings reached by the process are stored until reset by the user or until power is cycled.

Password: Three programmable passwords restrict modification of programmed settings and two prevent resetting the totals.

Non-Volatile Memory: All programmed settings are stored in non-volatile memory for a minimum of ten years if power is lost.

Power Options: 85-265 VAC 50/60 Hz, 90-265 VDC 20 W max, or 12-24 VDC ±10%, jumper selectable, 15 W max.

Fuse: Required external fuse: UL Recognized, 5 A max, slow blow; up to 6 batch controllers may share one 5 A fuse.

Normal Rejection Mode: Greater than 60 dB at 50/60 Hz

Isolation: 4 kV input/output-to-power line. 500 V input-to-output or output-to-P+ supply.

Overvoltage Category: Installation Overvoltage Category II: Local level with smaller transient overvoltages than Installation Overvoltage Category III.

Connections: Removable screw terminal blocks accept 12 to 22 AWG wire, RJ45 for external relays, digital I/O, and serial communication adapters.

Warranty: 3 years parts & labor

USB Connection: Compatibility: USB 2.0 Standard, Compliant

Connector Type: Micro-B receptacle

Cable: USB A Male to Micro-B Cable

Driver: Windows 98/SE, ME, 2000, Server 2003/2008, XP 32/64-Bit,

Vista 32/64-Bit, Windows 7 32/64-Bit, Windows 10 32/64-Bit

Power: USB Port

Pulse Input

Inputs: Field selectable: Pulse or square wave 0-5 V, 0-12 V, or 0-24 V @ 30 kHz; TTL; open collector 4.7 kΩ pull-up to 5 V @ 30 kHz; NPN or PNP transistor, switch contact 4.7 kΩ pull-up to 5 V @ 40 Hz; coil (sine wave) 40 mVp-p min @ 10 kHz; Modbus PV (Slave)

Low Voltage Mag Pickup (Isolated): Sensitivity: 40 mVp-p to 8 Vp-p

Minimum Input Frequency: 0.001 Hz - Minimum frequency is dependent on high gate setting.

Maximum Input Frequency: 30,000 Hz (10,000 for Low Voltage Mag Pickup)

Input Impedance: Pulse input: Greater than 300 kΩ @ 1 kHz. Open collector/switch input: 4.7 kΩ pull-up to 5 V.

Accuracy: ±0.03% of calibrated span ±1 count

Display Update Rate: Total: 10/sec, Rate: 10/sec to 1/1000 sec

Temperature Drift: Rate display is not affected by changes in temperature.

Multi-Point Linearization: 2 to 32 points

Low-Flow Cutoff: 0-999999 (0 disables cutoff function)

Decimal Point: Up to five decimal places or none: *dddddd*, *ddddd*, *dddddd*, *dddddd*, *dddddd*, or *dddddd*.

Calibration: May be calibrated using K-factor, scale using internal calibration, or calibrate by applying an external calibration signal.

K-Factor: Field programmable K-factor converts input pulses to rate in engineering units. May be programmed from 0.00001 to 999,999 pulses/unit.

Calibration Range: Input 1 signal may be set anywhere in the range of the batch controller; input 2 signal may be set anywhere above setting.

Filter: Programmable contact de-bounce filter, 40 to 999 Hz maximum input frequency allowed with low speed filter.

Time Base: Second, minute, hour, or day

Low Gate: 0.1-99.9 seconds; this function determines how often the incoming pulses are calculated and the rate display is updated.

High Gate: 2.0-999.9 seconds; this function determines how long to wait for pulses before the display goes to zero. This function is used to display slow pulse rates.

Note: The combination of the low and high gate functions makes it possible to have a fast display update for fast pulse rates while displaying slow pulse rates, if needed. For example: If the low gate is set to 1.0 second and the high gate to 999.9 second, with a fast pulse rate the display is updated every second; with a slow pulse rate the batch controller is capable of waiting up to 999.9 seconds before calculating the rate, making it possible to display a very slow rate down to 1 pulse/999.9 second (0.001 pulse/second).

Batch Controller

Rate Display Indication: 0 to 999999, lead zero blanking. "R" LED illuminates while displaying rate.

Total Displays & Grand Total Overflow: 0 to 999,999; automatic lead zero blanking. "T" LED is illuminated while displaying batch total and "GT" for grand total. Up to 999,999,999 with total-overflow feature. "oF" is displayed to the left of grand total overflow and ▲ LED is illuminated.

Batch Total Decimal Point: Up to five decimal places or none: *dddddd*, *ddddd*, *dddddd*, *dddddd*, *dddddd*, or *dddddd*.
Total decimal point is independent of rate decimal point.

Totalizer: Calculates total based on rate and field programmable multiplier to display total in engineering units. Time base must be selected according to the time units in which the rate is displayed.

Total Conversion Factor: 0.00001 to 999,999

Batch Preset: 0.00001 to 999,999 based on batch total decimal point.

Automatic Batch Restart Delay: 00000.1 to 999.9 seconds. The batch will automatically restart after completion of the last batch.

Grand Total Rollover: Totalizer rolls over when display exceeds 999,999,999. Relay status reflects the display value.

Grand Total Alarms: Up to seven, user selectable under Setup menu. Any set point can be assigned to grand total and may be programmed anywhere in the range of the batch controller for grand total alarm indication. Note that Relay 1 should always be assigned to batch control (εαεRL).

Grand Total Reset: Via front panel button, external contact closure on digital inputs, automatically via user selectable preset value and time delay, or through serial communications.

Grand Total Reset Password: A grand total password may be entered to prevent resetting the grand total from the front panel.

Non-Resettable Grand Total: The grand total can be programmed as a non-resettable total by entering the password "050873".

Caution: Once the Grand Total has been programmed as "non-resettable" the feature cannot be disabled.

Relays

Rating: 2 or 4 SPDT (Form C) internal and/or 4 SPST (Form A) external; rated 3 A @ 30 VDC and 125/250 VAC resistive load; 1/14 HP (≈ 50 W) @ 125/250 VAC for inductive loads

Noise Suppression: Noise suppression is recommended for each relay contact switching inductive loads.

Relay Assignment: Relays may be assigned to batch control, sampling, rate, or grand total alarms.

Preclose: 0-100% of batch size, individually user programmable for each additional batch control relay beyond the first.

Alarm Deadband: 0-100% of span, user programmable

High or Low Alarm: User may program any alarm for high or low trip point. Unused alarm LEDs and relays may be disabled (turned off).

Batching Relay Operation: Single or (2 to 8) multi-relay batching with

optional preclose for multi-stage operation. Each additional relay may be programmed with an individual preclose value.

Alarm Relay Operation: Automatic (non-latching), latching (requires manual acknowledge), sampling (based on rate or grand total), pump alternation control (2 to 8 relays), off (disable unused relays), and manual on/off control mode. Alarms are active only when the batch is running.

Alarm Relay Reset: User selectable via front buttons, digital inputs, or PC

1. Automatic reset only (non-latching), when input passes the reset point or total is reset to zero.
2. Manual reset only, when batch is stopped (latching).
3. Manual reset only after alarm condition has cleared (latching)

Note: Front panel button or digital input may be assigned to acknowledge relays programmed for manual reset. This replaces one of the standard batch control function keys. Only the PAUSE/STOP key function is possible during a batch process, so manual reset may only be done when the batch controller is in STOP mode.

Deadband: 0-100% of span, user programmable

Time Delay: 0 to 999.9 seconds, on & off relay time delays. Programmable and independent for each relay.

Fail-Safe Operation: Programmable and independent for each relay.

Note: Relay coil is energized in non-alarm condition. In case of power failure, relay will go to alarm state.

Auto Initialization: When power is applied, relays will reflect the state of the input. Alarms are active only when the batch is running.

Isolated 4-20 mA Transmitter Output

Output Source: Rate/process, total, grand total, max, min, set points 1-8, manual control setting, or Modbus input

Scaling Range: 1.000 to 23.000 mA for any display range

Calibration: Factory calibrated: 4.000 to 20.000 = 4-20 mA output

Analog Output Programming: 23.000 mA maximum for all parameters: Overrange, underrange, max, min, and break

Accuracy: ± 0.1% FS ± 0.004 mA

Temperature Drift: 0.4 µA/°C max from 0 to 65°C ambient, 0.8 µA/°C max from -40 to 0°C ambient

Note: Analog output drift is separate from input drift.

Isolated Transmitter Power Supply: Terminals I+ & R: 24 VDC ± 10%. Isolated from the input at >500 V. May be used to power the 4-20 mA output or other devices.

External Loop Power Supply: 35 VDC maximum

Output Loop Resistance:

Power supply	Minimum	Maximum
24 VDC	10 Ω	700 Ω
35 VDC (external)	100 Ω	1200 Ω

Serial Communications

Protocol: Modbus RTU

Batch controller Address/Slave ID: 1 - 247

Baud Rate: 300 - 19,200 bps

Transmit Time Delay: Programmable between 0 and 199 ms or transmitter always on for RS-422 communication

Data: 8 bit (1 start bit, 1 or 2 stop bits)

Parity: Even, odd, or none with 1 or 2 stop bits

Byte-to-Byte Timeout: 0.01 - 2.54 seconds

Turn Around Delay: Less than 2 ms (fixed)

Note: Refer to the ProVu Modbus Register Tables located at www.predig.com for details.

PD6310-WM Specifications

Enclosure: 1/8 DIN, high impact plastic, UL 94V-0, color: black

Front Panel: UL Type 4X, NEMA 4X/IP65; panel gasket provided

Programming Methods: Four front panel buttons, digital inputs, PC and MeterView Pro software, Modbus registers, or cloning using Copy function.

Isolated Transmitter Power Supply: Terminals P+ & P-: 24 VDC ± 10%.

Internally selectable jumper for 24, 10, or 5 VDC supply.

85-265 VAC models rated @ 200 mA max, 12-24 VDC powered models rated @ 100 mA max, @ 50 mA max for 5 or 10 VDC supply.

Environmental:

Operating temperature range: -40 to 65°C

Storage temperature range: -40 to 85°C

Relative humidity: 0 to 90% non-condensing

Mounting: 1/8 DIN panel cutout required: 3.622" x 1.772" (92 mm x 45 mm).

Dimensions: 4.68" x 2.45" x 5.64" (119 mm x 62 mm x 143 mm) (W x H x D)

Weight: 9.5 oz. (269 g)

Low Voltage Directive: EN 61010-1:2001

Safety requirements for measurement, control, and laboratory use

UL & cUL Listed: USA & Canada UL 508 Industrial Control Equipment

UL File Number: E160849

PD8-6310-WM Specifications

Enclosure: Die-cast aluminum with corrosion-resistant epoxy coating.

Type: NEMA 4X, IP68. Color: Blue

Programming Methods: Four front panel buttons, SafeTouch buttons, digital inputs, PC and MeterView Pro software, Modbus registers, or cloning using Copy function.

Isolated Transmitter Power Supply: Terminals P+ & P-: 24 VDC ± 10%.

internally selectable jumper for 24, 10, or 5 VDC supply.

All models transmitter supply rated @ 25mA max.

Max Power Dissipation: PD8 Series: Maximum power dissipation limited to 15.1 W.

Digital Inputs: Four. High: 3 to 5 VDC, Low: 0 to 0.4 VDC, Sink: 1.5 mA max.

Digital Outputs: Four. High: 4.75 VDC, Low: 0 to 0.4 VDC, Source: 15 mA max.

+5V Terminal: +5 VDC terminal for use with digital inputs only.

Serial Communications: RS-485 half-duplex (3-wire) connection

Environmental:

T6 Class operating temperature range Ta = -40 to 60°C

T5 Class operating temperature range Ta = -40 to 65°C

Storage temperature range: -40 to 85°C

Relative humidity: 0 to 90% non-condensing

Mounting: Four cast-in mounting flanges for wall or pipe mounting

Dimensions: 6.42" x 7.97" x 8.47" (163 mm x 202 mm x 215 mm) (W x H x D)

Weight: Approximately 16.0 lbs (7.26 kg)

Agency Approvals:

FM Approved: Enclosure: Type 4X; IP66

Class I, Division 1, Groups B, C, D; Class II, Division 1, Groups E, F, G; Class III, Division 1, T5/T6; Class I, Zone 1, AEx d, IIC Gb T5/T6; Zone 21, AEx tb IIIC T90°C; Ta -40°C to +65°C

T6 Ta = -40°C to +60°C; T5 Ta = -40°C to +65°C

Certificate Number: 3047283

CSA Certified: Class I, Division 1, Groups B, C, D; Class II, Division 1, Groups E, F, G; Class III, Division 1:

Class 1 Zone 1 Ex d IIC; Zone 21 Ex tb IIIC T90°C:

-40°C < Tamb. < +60° C; Temperature Code T6

-40°C < Tamb. < +65° C; Temperature Code T5

Enclosure Type 4X & IP66

Certificate Number: 2531731

ATEX Certified: II 2 G D, Ex d IIC T* Gb, Ex tb IIIC T90°C Db IP68.

Ta = -40 to +*°C. *T6 = -40 to +60°C, *T5 = -40 to +65°C

Certificate Number: Sira 12ATEX1182

IECEX Certified: Ex d IIC T* Gb, Ex tb IIIC T90°C Db IP68.

Ta = -40 to +*°C. *T6 = -40 to +60°C, *T5 = -40 to +65°

Certificate Number: IECEX SIR 12.0073

NTEP Weights and Measures Certification

Certificate Number: 14-061

Definition: Register for Meter

Stationary Wholesale Liquid Register/Batch controller Digital Electronic

Model: PD63XX Series and PD8-63XX Series

Evaluation Criteria: NIST Handbook 44 Specifications, Tolerances, and Other Technical Requirements for Weighing and Measuring Devices, 2014 Edition. NCWM Publication 14 Measuring Devices, 2014 Edition.

National Conference on Weights and Measures (NCWM) National Type Evaluation Program (NTEP) Certificate of Conformance available at www.predig.com.

MeterView Pro Specifications

System Requirements: Windows® 2000/XP/Vista/7/8/10

Communications: RS-232 Adapter or RS-422/485 Adapter

Meter Address: 1 - 247

Reports: Data logging: Save as CSV file format

Configuration: Save as PDC file format or print configuration

Baud Rate: 300 - 19,200 bps

Configuration: One meter at a time

Protocol: Modbus RTU (requires PROVU firmware version 2.0 or higher)

Securing the Unit

Once the operator has completed programming the PD6310-WM for the desired application, it is time to secure the unit. First, power down the meter and remove all connectors. Unscrew the back cover and slide it back about 1 inch. Then, configure the JP1 jumper, located behind the input signal connector, for the desired programming lockout operation (On or Off), as shown below in **Figure 1**. Return the back cover to its normal position.

NTEP Wire Security Seal Installation

Once the Lockout Jumper has been installed, the operator can install the wire security seal to complete the Lockout Procedure. Be sure the security seal mounting bracket (identified by the wire loop pass-through located next to the mounting screw) is located on the side of the case with the wire loop pass-through holes. Pass the wire security loop through the wire loop pass-through holes on the rear portion of the batch controller housing, then through the pass-through holes on the security bracket (next to the mounting screw). With the wire loop through the rear of the case and the mounting bracket, pass the loop back through the crimp seal end. Tighten the loop such that it will prevent the rear of the case from being removed while the loop is in place. The wire loop may now be tagged, crimped, and sealed to mechanically secure both the rear case and the programming lockout jumper contained within. Proper Wire Security Loop installation can be seen in **Figure 2**.

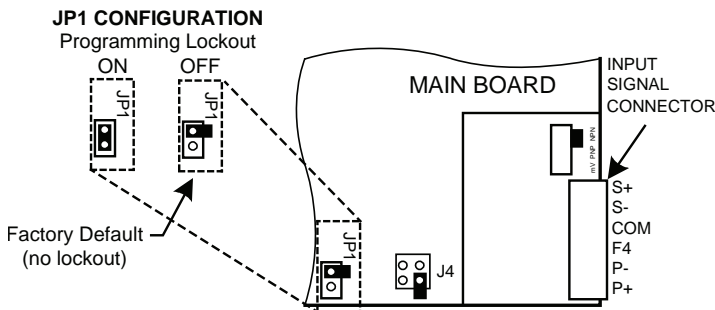

Figure 1. Programming NTEP Lockout Jumper

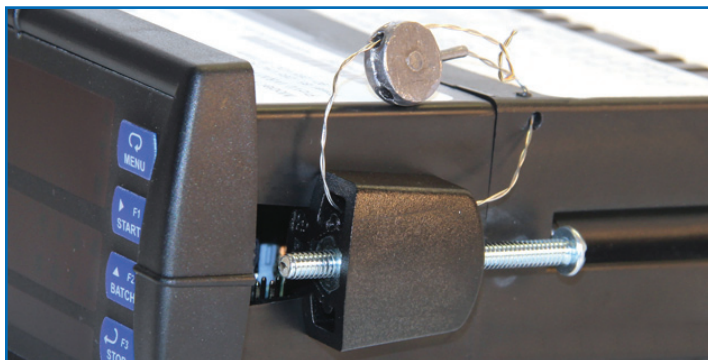

Figure 2. Proper Wire Security Loop Installation

Disclaimer

The information contained in this document is subject to change without notice. Precision Digital Corporation makes no representations or warranties with respect to the contents hereof, and specifically disclaims any implied warranties of merchantability or fitness for a particular purpose. ©2014-2016 Precision Digital Corporation. All rights reserved.

ORDERING INFORMATION

ProVu® PD6310-WM Pulse Input Batch Controller		
85-265 VAC Model	12-24 VDC Model	Options Installed
PD6310-6H2-WM	PD6310-7H2-WM	2 Relays
PD6310-6H4-WM	PD6310-7H4-WM	4 Relays
PD6310-6H5-WM	PD6310-7H5-WM	2 Relays & 4-20 mA Output
PD6310-6H7-WM	PD6310-7H7-WM	4 Relays & 4-20 mA Output

Note: SunBright displays are standard on all models of the PD6310-WM and PD8-6310-WM.
Note: 24 V flowmeter power supply standard on all models.

ProtEX-MAX™ PD8-6310-WM Pulse Input Batch Controller		
85-265 VAC Model	12-24 VDC Model	Options Installed
PD8-6310-6H2-WM	PD8-6310-7H2-WM	2 Relays
PD8-6310-6H4-WM	PD8-6310-7H4-WM	4 Relays
PD8-6310-6H5-WM	PD8-6310-7H5-WM	2 Relays & 4-20 mA Output
PD8-6310-6H7-WM	PD8-6310-7H7-WM	4 Relays & 4-20 mA Output

Note: SunBright displays are standard on all models of the PD6310-WM and PD8-6310-WM.
Note: 24 V flowmeter power supply standard on all models.

Accessories	
Model	Description
PDA1002	DIN Rail Mounting Kit for Two Expansion Modules*
PDA1004	4-Relay Expansion Module*
PDA1044	4 Digital Inputs & 4 Digital Outputs Module*
PDA1232	RS-232 Serial Adapter*
PDA1485	RS-422/485 Serial Adapter*
PDA7485-I	RS-232 to RS-422/485 Isolated Converter
PDA7485-N	RS-232 to RS-422/485 Non-Isolated Converter
PDA8232-N	USB to RS-232 Non-Isolated Converter
PDA8485-I	USB to RS-422/485 Isolated Converter
PDA8485-N	USB to RS-422/485 Non-Isolated Converter
PDX6901	Suppressor (snubber): 0.01 µF/470 Ω, 250 VAC*
PDAPLUG75	3/4" NPT 316 Stainless Steel Stopping Plug with Approvals**
PDA6846	Pipe Mounting Kit Zinc Plated (Requires 2)**
PDA6846-SS	Pipe Mounting Kit Stainless Steel (Requires 2)**

*For use with the ProVu Series PD6310-WM only.

**For use with the ProtEX-MAX Series PD8-6310-WM only.

Your Local Distributor is:

LDS6310-WM_C 05/16