

Serial Communication Converters & Adapters

Instruction Manual



**PDA1232 ProVu RS-232
Serial Adapter**



**PDA1485 ProVu RS-485
Serial Adapter**



**PDA7232 Trident RS-232
Serial Adapter**



**PDA7422 Trident RS-485
Serial Adapter**



**PDA7485 RS-232 to
RS-485 Converter**



**PDA8006 Trident to USB
Serial Adapter**
**PDA8008 ProVu to USB
Serial Adapter**



**PDA8232 USB to RS-232
Converter**



**PDA8485 USB RS-485
Converter**

- Provide Convenient Way to Bring Data from Meter Into PC, PLC, etc.
- RS-232 and RS-485 Adapters Available
- USB to RS-485 and RS-232 Converters Available for Trident and for ProVu Meters
- PDA8006 USB Adapter Great for Programming Trident Meter

PRECISION DIGITAL CORPORATION

233 South Street • Hopkinton MA 01748 USA
Tel (800) 343-1001 • Fax (508) 655-8990

www.predig.com



Disclaimer

The information contained in this document is subject to change without notice. Precision Digital makes no representations or warranties with respect to the contents hereof, and specifically disclaims any implied warranties of merchantability or fitness for a particular purpose. See Warranty Information and Terms & Conditions on www.predig.com for complete details.

CAUTION

- Read complete instructions prior to installation and operation of the meter.

WARNINGS

- Risk of electric shock or personal injury.
- These products are not recommended for life support applications or applications where malfunctioning could result in personal injury or property loss. Anyone using these products for such applications does so at his/her own risk. Precision Digital Corporation shall not be held liable for damages resulting from such improper use.

WARNING
Cancer and Reproductive Harm - www.P65Warnings.ca.gov

Limited Warranty

Precision Digital Corporation warrants these products against defects in material or workmanship for the specified period under "Specifications" from the date of shipment from the factory. Precision Digital's liability under this limited warranty shall not exceed the purchase value, repair, or replacement of the defective unit. See Warranty Information and Terms & Conditions on <http://www.predig.com> for complete details.

Registered Trademarks

All trademarks mentioned in this document are the property of their respective owners.

© 2020 Precision Digital Corporation.
All rights reserved.

Introduction

Precision Digital provides an assortment of serial communications adapters and converters to enhance the utility of its products. These external devices connect to the RJ11 / RJ45 header at the back of the instrument and allow the meter to communicate over RS-232, RS-485 or USB. One of the most useful of these devices is the PDA8006 USB adapter which allows the PD765 or PD8-765 to connect to a PC running free MeterView programming software via the USB port as pictured below:



Note: Trident meter is not powered from USB connection and requires external power to be programmed.

Ordering Information

Model	Description
PDA1232	PROVu RS-232 Adapter
PDA1485	PROVu RS-485 Adapter
PDA7232	Trident RS-232 Adapter, PDA7420 included
PDA7420	Trident Meter Copy Cable 7' (2.1 m)
PDA7422	Trident RS-485 Adapter, PDA7420 included
PDA7485-I	RS-232 to RS-485 Isolated Converter
PDA8006	Trident USB Adapter for programming only
PDA8008	PROVu USB Adapter for programming meter when powered from AC or DC
PDA8232-N	USB to RS-232 Non-Isolated Converter
PDA8485-I	USB to RS-485 Isolated Converter
MeterView	MeterView Software for PD765 and PD8-765 meters. FREE download available at www.predig.com
MeterView Pro	MeterView Pro Software for PROVu, Helios, and ProtEX MAX meters. Pre-loaded to meter. FREE download available at www.predig.com .

Accessories

Model	Description
PDA1002	DIN rail mounting kit for two devices

Table of Contents

Introduction	2
Ordering Information	2
Specifications.....	5
PDA1232 ProVu RS-232 Adapter	5
PDA1485 ProVu RS-485 Adapter	5
PDA7232 Trident RS-232 Adapter	5
PDA7420 Trident Meter Copy Cable	5
PDA7422 Trident RS-485 Adapter	5
PDA7485 RS-232 to RS-485 Converter.....	5
PDA8006 Trident USB Adapter.....	6
PDA8008 ProVu USB Adapter	6
PDA8232 USB to RS-232 Converter	6
PDA8485 USB to RS-485 Converter	6
General (All)	6
USB Drivers for Serial Communications Adapters	6
DIN Rail Mounting Instructions	7
Serial Communications Overview	8
PDA1232 ProVu RS-232 Serial Adapter.....	9
Description.....	9
Installation.....	9
Connections.....	9
PDA1485 ProVu RS-485 Serial Adapter.....	10
Description.....	10
Installation.....	10
Connections.....	10
PDA7232 Trident RS-232 Serial Adapter.....	11
Description.....	11
Installation.....	11
Connections.....	11
PDA7420 Trident Meter Copy Cable.....	11
Description.....	11
Connections.....	11
Operation.....	11
PDA7422 Trident RS-485 Serial Adapter.....	12
Description.....	12
Installation.....	12
Connections.....	13
PDA7485 RS-232 to RS-485 Converter.....	13
Description.....	13
Installation.....	13
Connections.....	14
PDA8006 Trident to USB Serial Adapter.....	15
Description.....	15
Installation.....	15
USB Drivers for PDA8006	15
PDA8008 ProVu to USB Serial Adapter	15
Description.....	15
Installation.....	15
USB Drivers for PDA8008	15
PDA8232 USB to RS-232 Converter	16
Description.....	16
Installation.....	16
PDA8485 USB RS-485 Converter.....	16
Description.....	16
Installation.....	16
Connections.....	17
Troubleshooting.....	18

Table of Figures

Figure 1. DIN Rail Clips Mounted to Expansion Module7

Figure 2. Hinge & Latch End of DIN Rail Clip7

Figure 3. DIN Rail Clips Mounted to Module7

Figure 4. Examples of Clips Mounted to Modules7

Figure 5. Mounting the DIN Rail with 2 #10 Pan Head Screws7

Figure 6. Examples of Modules Mounted to DIN Rail7

Figure 7. Snapping the Module to the DIN Rail7

Figure 8. Typical Installation of DIN Rail Mounted Devices7

Figure 9. General Four-Wire Network Connections.....8

Figure 10. General Two-Wire Network Connections8

Figure 11. RS-232 Adapter Connections9

Figure 12. RS-422 or RS-485 Wiring10

Figure 13. RS-485 Two-Wire Multi-Drop Wiring10

Figure 14. Connections for PDA1485 to Serial Converter.....10

Figure 15. RS-232 Adapter Connections11

Figure 16. Standard Modular Cable Wiring11

Figure 17. Trident Copy Cable Connecting Two Meters11

Figure 18. RS-422 or RS-485 Wiring12

Figure 19. RS-485 Two-Wire Multi-Drop Wiring12

Figure 20. Standard Modular Cable Wiring13

Figure 21. Connections for PDA7422 to Serial Converter.....13

Figure 22. PDA7485 Connections and DIP Switch Settings13

Figure 23. PDA7485 DIP Switch Settings Chart14

Figure 24. PDA7485 RS-485 Two-Wire Multi-Drop Wiring.....14

Figure 25. Connections for PDA7485 in a Four-Wire Network14

Figure 26. Connections for PDA7485 in a Two-Wire Network14

Figure 27. Trident USB Adapter Connections.....15

Figure 28. ProVu USB Adapter Connections15

Figure 29. Connections for PDA8232 to serial device.....16

Figure 30. PDA8485 DIP Switch Location.....16

Figure 31. PDA8485 DIP Switch Settings.....17

Figure 32. Connections for PDA8485 in a Four-Wire Network17

Figure 33. Connections for PDA8485 in a Two-Wire Network17

Figure 34. PDA8485 RS-485 Two-Wire Multi-Drop Wiring.....17

Specifications

PDA1232 ProVu RS-232 Adapter

Compatibility	EIA-232
Connectors	PC compatible 9-pin D subminiature connector (DB9) and RJ45 (adapter to meter)
Cable	6' (1.8 m) standard Cat5e cable provided with adapter
Dimension	1.7" x 0.9" x 2.7" (43 mm x 24 mm x 70 mm) (W x H x D)
Distance	Adapter to: ProVu meter: 6' (1.8 m) max; Computer: 50' (15 m) max; Serial interface cable not provided
Power	Powered by ProVu meter M-Link connection
Status Indication	Separate LEDs for Power (P) Transmit (TX), and Receive (RX).

PDA1485 ProVu RS-485 Adapter

Compatibility	EIA-485
Connectors	Removable screw terminal connector and RJ11 (adapter to meter)
Cable	6' (1.8 m) standard Cat5e cable provided with adapter
Dimension	1.7" x 0.9" x 3.0" (43 mm x 24 mm x 76 mm) (W x H x D)
Distance	Adapter to: ProVu meter: 6' (1.8 m) max; Computer: 3,937' (1,200 m) max
Power	Powered by ProVu meter M-Link connection
Status Indication	Separate LEDs for Power (P), Transmit (TX), and Receive (RX)

PDA7232 Trident RS-232 Adapter

Compatibility	EIA-232
Connectors	PC compatible 9-pin D subminiature connector (DB9) and RJ11 (adapter to meter)
Cable	7' (2.1 m) standard modular cable provided with adapter
Dimension	1.7" x 0.9" x 2.7" (43 mm x 24 mm x 70 mm) (W x H x D)
Distance	Adapter to: PD765 meter: 7' (2.1 m) max; Computer: 50' (15 m) max; Serial interface cable not provided
Power	Powered by Trident PD765 RJ11 connection
Status Indication	Separate LEDs for Power (P), Transmit (TX), and Receive (RX)

PDA7420 Trident Meter Copy Cable

Purpose	To clone programming from one Trident meter to another
Connectors	RJ11
Cable	One 7' (2.1 m) standard modular cable

PDA7422 Trident RS-485 Adapter

Compatibility	EIA-485
Connectors	Removable screw terminal connector and RJ11 (adapter to meter)
Cable	7' (2.1 m) standard modular cable provided with adapter
Dimension	1.7" x 0.9" x 3.0" (43 mm x 24 mm x 76 mm) (W x H x D)
Distance	Adapter to: PD765 meter: 7' (2.1 m) max; Computer: 3,937' (1,200 m) max
Power	Powered by Trident PD765 RJ11 connection
Status Indication	Separate LEDs for Power (P), Transmit (TX), and Receive (RX)

PDA7485 RS-232 to RS-485 Converter

Compatibility	EIA-232, EIA-422, and EIA-485
Connectors	Screw terminal connector and DB9
Dimension	1.7" x 0.9" x 3.3" (43 mm x 24 mm x 83 mm) (W x H x D)
Distance	RS-232 connection: 50' (15 m) max; RS-485 connection: 3,937' (1,200 m) max
Number of Units	Up to 31 RS-485 compatible devices
Power	9-12 VDC; 115 VAC/12 VDC adapter included
Status Indication	Separate LEDs for Power (P), Transmit (TX), and Receive (RX)
Isolation	1500 VAC between data lines; 700 VDC input/output-to-power

PDA8006 Trident USB Adapter

Purpose	To be used only for programming the Trident meter
Compatibility	USB 1.1, USB 2.0
Connectors	RJ11, and USB Type B
Cable	One 7' (2.1 m) standard modular cable and one 3.28' (1.0 m) USB A-B Male cable provided with adapter
Dimension	1.7" x 0.8" x 3.3" 43 mm x 21 mm x 83 mm (W x H x D)
Distance	Adapter to: PD765/PD8-765 meter: 7' (2.1 m) max; USB connection to PC: 10' (3 m) max
Driver Compatibility	Win 98/2000/ME/XP/Vista/7/8/10
Power	USB Port
Status Indication	Separate LEDs for Power (P), Transmit (TX), and Receive (RX)

PDA8008 ProVu USB Adapter

Purpose	Programming (only) ProVu meter when meter powered from AC or DC.
Compatibility	USB 1.1, USB 2.0
Connectors	RJ45, and USB Type B
Cable	One 6' (1.8 m) standard Cat5e cable and one 3.28' (1.0 m) USB A-B Male cable provided with adapter
Dimension	1.7" x 0.8" x 3.3" 43 mm x 21 mm x 83 mm (W x H x D)
Distance	Adapter to: ProVu meter: 6' (1.8 m) max. USB connection: 10' (3 m) max
Driver Compatibility	Win 98/2000/ME/XP/Vista/7/8/10
Power	USB Port
Status Indication	Separate LEDs for Power (P), Transmit (TX), and Receive (RX)

PDA8232 USB to RS-232 Converter

Compatibility	USB 1.1, USB 2.0, EIA-232
Connectors	PC compatible 9-pin D subminiature connector (DB9) and USB Type A
Dimension	3' (91.44 cm) (Length)
Distance	USB connection: 10' (3 m) max; RS-232 connection: 50' (15m) max
Driver Compatibility	Win 98/2000/ME/XP/Vista/7/8/10
Power	USB port

PDA8485 USB to RS-485 Converter

Compatibility	USB 1.1, USB 2.0, EIA-422, and EIA-485
Connectors	Screw terminal connector and USB Type B
Dimension	1.7" x 0.9" x 3.0" (43 mm x 24 mm x 76 mm) (W x H x D)
Distance	USB connection: 10' (3 m) max; RS-485 connection: 3,937' (1,200 m) max
Driver Compatibility	Win 98/2000/ME/XP/Vista/7/8/10
Number of Units	Up to 31 RS-485 compatible devices
Power	USB Port
Status Indication	Separate LEDs for Power (P), Transmit (TX), and Receive (RX)
Isolation	1500 VAC between data lines; 700 VDC input/output-to-power

General (All)

Warranty	1 year parts & labor. See Warranty Information and Terms & Conditions on www.predig.com for complete details.
-----------------	---

USB Drivers for Serial Communications Adapters

USB Drivers for serial communications adapters are available for download at:

[Software Downloads](#)

DIN Rail Mounting Instructions

The following instructions for expansion modules may be used for mounting the converters and adapters to DIN rails.

Step 1: Mounting the DIN Rail Clips to Module

Place the expansion module on a flat surface with the bottom surface facing up. The bottom surface can be identified as the surface closest to the locking tab slot on the modular connector as shown in *Figure 1*.

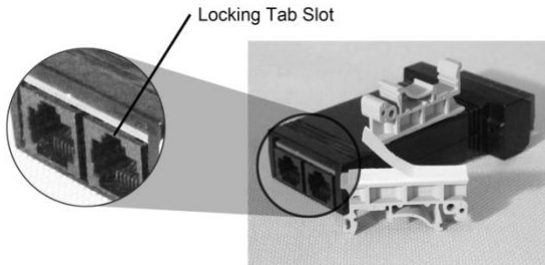

Figure 1. DIN Rail Clips Mounted to Expansion Module

Peel the protective layer off the adhesive tape on the bottom of one of the mounting clips. With the hinge end of the clip, as shown in *Figure 2*, facing the end of the module with the communications connector, align the clip along the long (side) edge of the module and centered lengthwise within the flat surface of the module as shown in *Figure 3*.

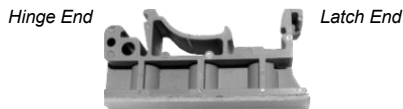

Figure 2. Hinge & Latch End of DIN Rail Clip



Figure 3. DIN Rail Clips Mounted to Module

Firmly press down on the clip for 10 seconds. Repeat this procedure on the opposite side. Once the clips are properly installed, the modules with clips mounted should look similar to one or both of the modules pictured in *Figure 4*. While the adhesive is initially quite strong, this strength improves significantly over a period of approximately 12 hours.

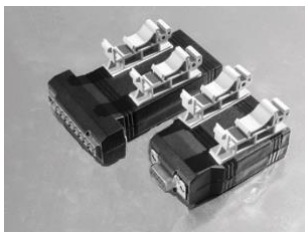

Figure 4. Examples of Clips Mounted to Modules

Step 2: Mounting the DIN Rail to a Surface

The expansion modules, serial adapters and serial converters weigh approximately 1.5 oz (42 grams) each so the mounting hardware does not need to be overly strong. We recommend two #10 pan head screws as shown in *Figure 5*, but only because they best accommodate the slots in the DIN rail. The

amount of strain the wiring might place on the module mounting needs to be considered also. In many cases, DIN rail with double-sided tape might be acceptable, although not recommended in areas of high vibration or extreme hot or cold temperatures.



Figure 5. Mounting the DIN Rail with 2 #10 Pan Head Screws

When choosing a location to mount the DIN rail, keep in mind that wires will be entering both ends of the modules as shown in *Figure 6*. Leave enough room on either end of module to allow for wire routing to prevent undue stress placed on the module's connectors and mounting clips. The DIN rail may be mounted on any vertical or horizontal mounting surface.

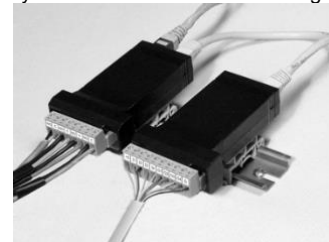

Figure 6. Examples of Modules Mounted to DIN Rail

Step 3: Mounting Modules to the DIN Rail

To mount modules to a DIN rail, first locate the approximate desired position to place the module on the DIN rail, then hook the hinge end of the mounting clip to the edge of the DIN rail as shown in *Figure 7*. Next lower the opposite "latch end" of the clip onto the rail. Press down on the module until the latch end snaps in place.

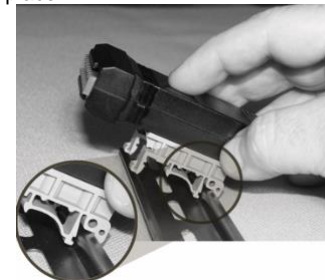

Figure 7. Snapping the Module to the DIN Rail

A typical installation will look like *Figure 8* once modules are mounted to the DIN rail.



Figure 8. Typical Installation of DIN Rail Mounted Devices

Step 4: Connections

After mounting the device(s), refer to the Instruction Manual for each module for proper connections and operation.

Serial Communications Overview

RS-232 and RS-485 are standard interfaces approved by the Electronic Industries Alliance (EIA) for connecting serial devices. In EIA terms, the device (e.g. meter) that connects to the interface is called a Data Communications Equipment (DCE) and the device to which it connects (e.g. the computer) is called a Data Terminal Equipment (DTE).

The RS-422 standard was designed to replace the older RS-232 standard because it supports higher data rates and greater immunity to electrical interference. RS-485 is similar to RS-422 but can support multi-point connections per line because it uses lower-impedance drivers and receivers.

Line drivers and receivers are used to exchange data between two or more points (nodes) on a serial communications network. Reliable data communications can be difficult in the presence of induced noise, ground level differences, and other hazards associated with installation of a network. When communicating at high data rates, or over long distances in real world environments, RS-232 is often inadequate. The differential data transmission of RS-422 and RS-485 offers superior performance in most applications. Differential signals can help nullify the effects of ground shifts and induced noise signals that can appear as common mode voltages on a network.

RS-422 was designed for greater distances and higher baud rates than RS-232. In its simplest form, a pair of converters from RS-232 to RS-422 (and back again) can be used to form an “RS-232 extension cord”. Data rates of up to 100 kbits/second and distances of 3,937’ (1,200 m) can be accommodated with RS-422.

RS-422 devices however cannot be used to construct a true multi-point network. A multi-point network consists of multiple drivers and receivers connected on a single bus, where any point (node) can transmit and/or receive data. RS-485 is an enhanced version of the RS-422 standard, which allows multiple drivers and receivers on the same two-wire or four-wire system. The RS-485 standard specifies up to 32 drivers and 32 receivers on a single bus, but with the introduction of “automatic” repeaters and high-impedance drivers/receivers, this number can be extended to hundreds of points (nodes) on a network.

The cabling used for an RS-422 or RS-485 serial communications network should always be a high-quality cable such as Belden 8162 or Alpha 6203C. A two-wire system requires two twisted pairs, and a four-wire system requires three twisted pairs (the extra twisted pair is needed for the signal ground).

Figure 9 illustrates how to connect a general four-wire network (a four-wire network actually contains 5 wires).

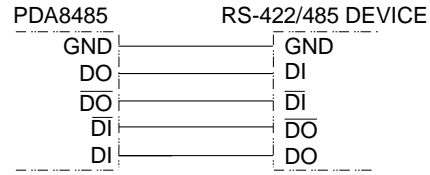

Figure 9. General Four-Wire Network Connections

Figure 10 illustrates how to connect a general two-wire network (a two-wire network actually contains 3 wires). Note that the PDA7485 and PDA8485 have DIP switches that allow for two-wire connections without the need to externally wire the DO to the DI and the /DO to the /DI (see the converter section for complete details).

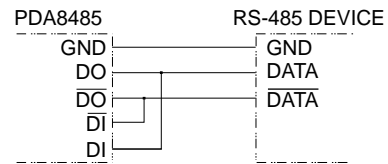

Figure 10. General Two-Wire Network Connections

PDA1232 ProVu RS-232 Serial Adapter



Description

The PDA1232 converts the serial output of the ProVu meter to an unbalanced, full-duplex RS-232 signal.

The RS-232 port has a female DB9 connector with pins 2 (RX output), 3 (TX input), and 5 (Signal Ground). Pins 7 (RTS) and 8 (CTS) are tied together, and pins 1 (CD), 4 (DTR), and 6 (DSR) are tied together. The adapter is powered by the ProVu meter M-Link connection.

Baud rates are adjustable and handled by the ProVu (see the ProVu Instruction Manual for more details).

The PDA1232 has three diagnostic LEDs: a Power (P) LED to show when the adapter is powered properly, a Transmit Data (TX) LED to show when the adapter is sending data out from the PC side, and a Receive Data (RX) LED to show when the adapter is receiving data from the ProVu meter.

Installation

Figure 11 shows the connection of a ProVu meter to a PC using the PDA1232 serial adapter. The PDA1232 has an RJ45 connector to connect the Cat5e cable and a PC compatible 9-pin D subminiature connector (DB9). The DB9 can be connected directly to the PC or by using a standard serial extension cable.

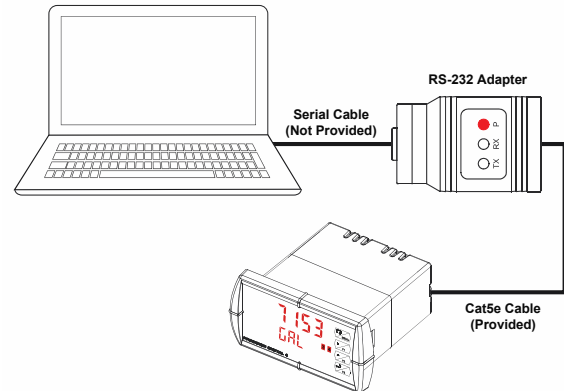

Figure 11. RS-232 Adapter Connections

Connections

A Cat5e cable is provided to connect the ProVu meter to the PDA1232 serial adapter.

PDA1485 ProVu RS-485 Serial Adapter



Description

The PDA1485 converts the serial output of the ProVu meter to balanced, full or half-duplex RS-485 signals.

The PDA1485 has a removable screw terminal connector for the RS-485 terminals which includes Transmit Data (DO) and (/DO), Receive Data (DI) and (/DI), and Signal Ground. The adapter is provided by the ProVu meter M-Link connection.

Baud rates are adjustable and handled by the ProVu (see the ProVu Instruction Manual for more details).

The PDA1485 has three diagnostic LEDs: a Power (P) LED to show when the adapter is powered properly, a Transmit Data (TX) LED to show when the adapter is sending data out from the PC side, and a Receive Data (RX) LED to show when the adapter is receiving data from the ProVu meter.

Installation

Figure 12 shows the connection of a ProVu meter to a PC using the PDA1485 serial adapter and a PDA7485 RS-232 to RS-485 converter in an RS-422 network. The PDA1485 has an RJ45 connector to connect the Cat5e cable and a screw terminal connector to connect to the RS-422 network.

Figure 13 shows the connection of ProVu meters with PDA1485 serial adapters to a PC using a PDA7485 RS-232 to RS-485 converter in an RS-485 network.

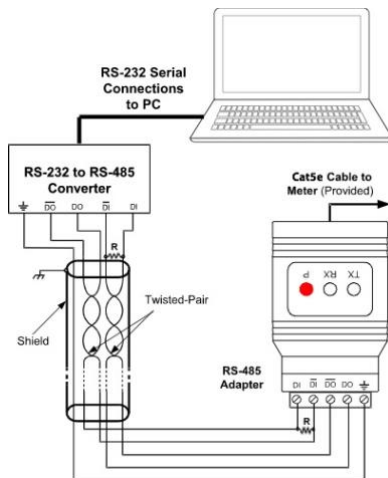

Figure 12. RS-422 or RS-485 Wiring

Notes:

1. Termination resistors are optional and values depend on the cable length and characteristic impedance. Consult the cable manufacturer for recommendations.
2. Refer to PDA7485 RS-232 to RS-485 Converter on page 13 for further details.
3. Use shielded cable, twisted-pairs plus ground. Connect ground shield only at one location.

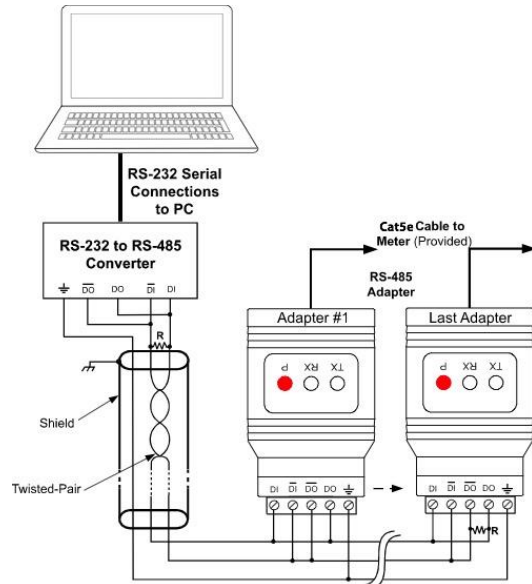

Figure 13. RS-485 Two-Wire Multi-Drop Wiring

Notes:

1. Termination resistors are optional and values depend on the cable length and characteristic impedance. Consult the cable manufacturer for recommendations.
2. Refer to PDA7485 RS-232 to RS-485 Converter on page 13 for further details.
3. Use shielded cable, twisted-pair plus ground. Connect ground shield only at one location.

Connections

A Cat5e cable is provided to connect the ProVu meter to the PDA1485 adapter.

Figure 14 details the wiring connections from the PDA1485 to an RS-485 serial converter (such as the PDA7485 or PDA8485) for a four-wire network.

PDA1485 to RS-485 Serial Converter Connections	
RS-485 Serial Converter	PDA1485 RS-485 Adapter
$\overline{\text{DI}}$	$\overline{\text{DI}}$
DO	DI
$\overline{\text{DI}}$	$\overline{\text{DO}}$
DI	DO

Figure 14. Connections for PDA1485 to Serial Converter

If the serial converter is configured for a two-wire network, then the requirement to externally wire the DO to the DI and the /DO to the /DI on the PDA1485 screw terminal connector is needed.

PDA7232 Trident RS-232 Serial Adapter



Description

The PDA7232 converts the serial output of the PD765 Trident meter to an unbalanced, full-duplex RS-232 signal.

The RS-232 port has a female DB9 connector with pins 2 (RX output), 3 (TX input), and 5 (Signal Ground). Pins 7 (RTS) and 8 (CTS) are tied together, and pins 1 (CD), 4 (DTR), and 6 (DSR) are tied together. The adapter is powered by the PD765 Trident meter.

Baud rates are adjustable and handled by the PD765 (see the Trident Instruction Manual for more details).

The PDA7232 has three diagnostic LEDs: a Power (P) LED to show when the adapter is powered properly, a Transmit Data (TX) LED to show when the adapter is sending data out from the PC side, and a Receive Data (RX) LED to show when the adapter is receiving data from the Trident PD765 meter.

Installation

Figure 15 shows the connection of a Trident meter to a PC using the PDA7232 serial adapter. The PDA7232 has an RJ11 connector to connect the PDA7420 modular cable and a PC compatible 9-pin D subminiature connector (DB9). The DB9 can be connected directly to the PC or by using a standard serial extension cable.

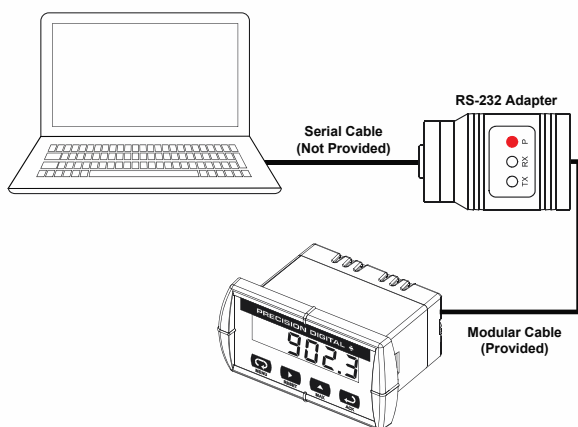

Figure 15. RS-232 Adapter Connections

Connections

A PDA7420 cable is provided to connect the Trident meter to the PDA7232 serial adapter. Figure 16 shows the PDA7420 cable details.

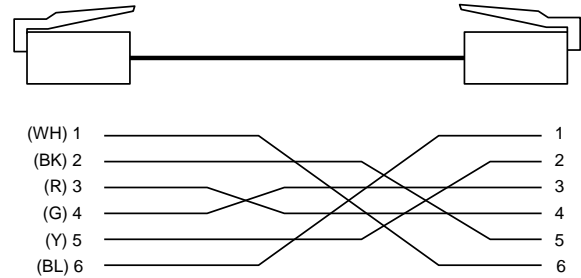

Figure 16. Standard Modular Cable Wiring

PDA7420 Trident Meter Copy Cable



Description

The PDA7420 Trident Meter Copy Cable is used to copy (or clone) all the settings from one Trident meter to other Trident meters requiring exactly the same setup and programming (i.e. type of input, scaling, decimal point, filter, bypass, etc.). The Copy operation can be completed in less than 10 seconds. The Copy function is a standard feature on all Trident meters.



Connections

Connect the two ends of the PDA7420 as shown in Figure 17.



Figure 17. Trident Copy Cable Connecting Two Meters

Operation

Refer to the PD765 or PD8-765 manual for instructions on how to perform the Copy function.

PDA7422 Trident RS-485 Serial Adapter



Description

The PDA7422 converts the serial output of the PD765 Trident meter to balanced, full or half-duplex RS-485 signals.

The PDA7422 has a removable screw terminal connector for the 485 terminals which includes Transmit Data (DO) and (/DO), Receive Data (DI) and (/DI), and Signal Ground.

Baud rates are adjustable and handled by the PD765 (see the Trident Instruction Manual for more details).

The PDA7422 has three diagnostic LEDs: a Power (P) LED to show when the adapter is powered properly, a Transmit Data (TX) LED to show when the adapter is sending data out from the PC side, and a Receive Data (RX) LED to show when the adapter is receiving data from the Trident PD765 meter.

Installation

Figure 18 shows the connection of a Trident meter to a PC using the PDA7422 serial adapter and a PDA7485 RS-232 to RS-485 converter in an RS-422 network. The PDA7422 has an RJ11 connector to connect the PDA7420 modular cable and a screw terminal connector to connect to the RS-422 network. Figure 19 shows the connection of several Trident meters with PDA7422 serial adapters to a PC using a PDA7485 RS-232 to RS-485 converter in an RS-485 network.

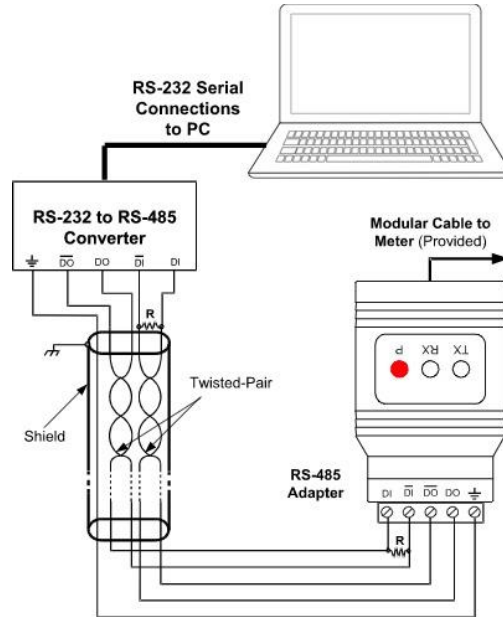

Figure 18. RS-422 or RS-485 Wiring

Notes:

1. Termination resistors are optional and values depend on the cable length and characteristic impedance. Consult the cable manufacturer for recommendations.
2. Refer to *PDA7485 RS-232 to RS-485 Converter* on page 13 for further details.
3. Use shielded cable, twisted-pairs plus ground. Connect ground shield only at one location.

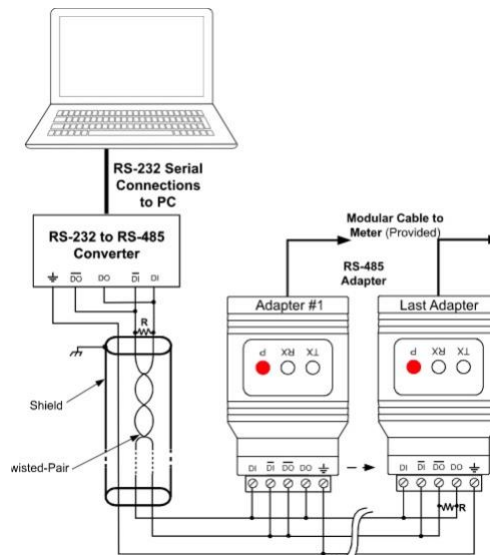

Figure 19. RS-485 Two-Wire Multi-Drop Wiring

Notes:

1. Termination resistors are optional and values depend on the cable length and characteristic impedance. Consult the cable manufacturer for recommendations.
2. Refer to *PDA7485 RS-232 to RS-485 Converter* on page 13 for further details.
3. Use shielded cable, twisted-pair plus ground. Connect ground shield only at one location.

Connections

A PDA7420 cable is provided to connect the Trident meter to the PDA7422 adapter. *Figure 20* shows the PDA7420 cable details.

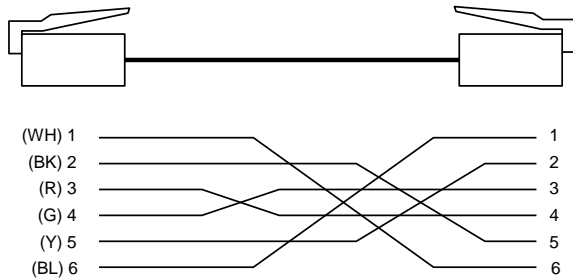

Figure 20. Standard Modular Cable Wiring

Figure 21 details the wiring connections from the PDA7422 to an RS-485 serial converter (such as the PDA7485 or PDA8485) for a four-wire network.

PDA7422 to RS-485 Serial Converter Connections	
RS-485 Serial Converter	PDA7422 RS-485 Adapter
\overline{DO}	\overline{DI}
DO	DI
\overline{DI}	\overline{DO}
DI	DO

Figure 21. Connections for PDA7422 to Serial Converter

If the serial converter is configured for a two-wire network then the requirement to externally wire the DO to the DI and the /DO to the /DI on the PDA7422 screw terminal connector is needed.

PDA7485 RS-232 to RS-485 Converter



Description

The PDA7485 converts unbalanced, full-duplex RS-232 signals to balanced, full or half-duplex RS-422 or RS-485 signals.

The RS-232 port, configured as a DTE port, has a female DB9 connector with pins 2 (RX output),

3 (TX input), and 5 (Signal Ground). Pins 7 (RTS) and 8 (CTS) are tied together, and pins 1 (CD), 4 (DTR), and 6 (DSR) are tied together. The RS-485 terminal blocks support Transmit Data (DO) and (/DO), Receive Data (DI) and (/DI), and Signal Ground. A separate terminal block supports the power input (+12VDC) and power ground (GND).

Baud rates are automatic and handled by the PDA7485.

The PDA7485 has three diagnostic LEDs: a Power (P) LED to show when the converter is powered properly, a Transmit Data (TX) LED to show when the converter is sending data out from the PC side, and a Receive Data (RX) LED to show when the converter is receiving data from the network side.

The DIP switch SW1 is located between the screw terminal connectors and allows for system configurations.

Installation

The DIP switch SW1 allows for several different options. Factory settings for the switch are shown in *Figure 22*.

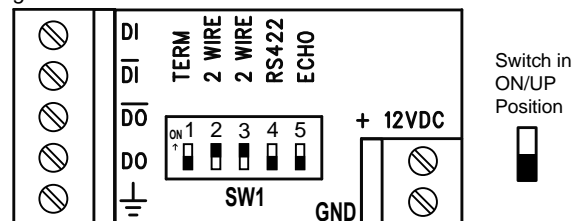

Figure 22. PDA7485 Connections and DIP Switch Settings

The TERM switch position adds an internal 120 ohm termination resistor when ON (up). Termination should be used on both ends of the network with high data rates and long wiring runs.

To configure a two-wire network set both of the 2 WIRE switch positions to ON (up). For a four-wire network set both of the 2 WIRE switches to OFF (down).

When the RS-422 switch position is ON (up) it is configured for an RS-422 network. For RS-485 networks set the RS-422 switch to OFF (down).

The ECHO switch position allows the data being sent from the RS-232 port to be echoed back into the RS-232 port. In most networks, this is an undesired effect and the ECHO switch would be OFF (down).

PDA7485 DIP Switch Settings	
SW1 Switch Position	ON Setting Function
1	Network Termination Included (120 ohm)
2	2-Wire Network Mode Connection (factory setting)
3	2-Wire Network Mode Connection (factory setting)
4	RS-422 Mode
5	ECHO Mode

Figure 23. PDA7485 DIP Switch Settings Chart

Figure 24 shows an example configuration of a two-wire network. Each device (e.g. Trident PD765 meter) connected to the same network must have a unique address.

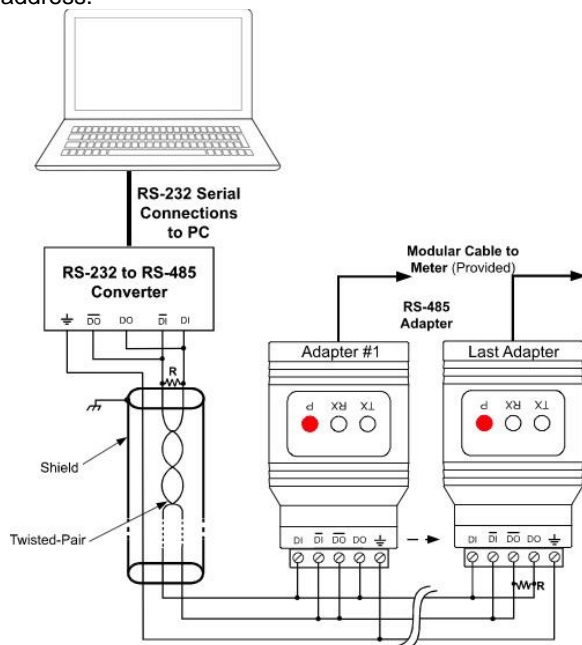

Figure 24. PDA7485 RS-485 Two-Wire Multi-Drop Wiring

Notes:

1. Termination resistors are optional and values depend on the cable length and characteristic impedance. Consult the cable manufacturer for recommendations.
2. Refer to *PDA7422 Trident RS-485 Serial Adapter* on page 12 for further details.
3. Use shielded cable, twisted-pair plus ground. Connect ground shield only at one location.

Connections

To power the PDA7485, connect 12 VDC to the +12VDC and ground to the GND screw terminals from the supplied 115 VAC/12 VDC adapter.

The PDA7485 may be configured for either a four-wire or two-wire network. *Figure 25* details the wiring connections from the PDA7485 to an RS-485 serial device in a four-wire network.

PDA7485 to RS-485 Serial Device Four-Wire Connections	
PDA7485 Serial Converter	RS-485 Serial Device
\overline{DO}	\overline{DI}
DO	DI
\overline{DI}	\overline{DO}
DI	DO

Figure 25. Connections for PDA7485 in a Four-Wire Network

Figure 26 details the wiring connections from the PDA7485 to an RS-485 serial device in a two-wire network when the DIP switches on the PDA7485 have been set to the “2-Wire Mode”.

PDA7485 to RS-485 Serial Device Two-Wire Connections	
PDA7485 Serial Converter	RS-485 Serial Device
\overline{DO}	\overline{DATA}
DO	DATA

Figure 26. Connections for PDA7485 in a Two-Wire Network

The PDA7485 internally connects the /DI to the /DO and the DI to the DO when the DIP switches are set to “2-Wire Mode”. Either the /DI or /DO could be used to connect to /DATA and either the DI or DO could be used to connect to DATA.

Two PDA7485 RS-232 to RS-485 Serial Converters could be used as a serial extender to allow RS-232 serial devices to communicate over long distances. This would allow an RS-232 device to operate up to 3,937' (1,200 m).

PDA8006 Trident to USB Serial Adapter



Description

The PDA8006 Trident to USB Serial Adapter allows for direct connection of a Trident meter to the USB port of a PC. It is intended only for programming the meter.

Installation

Figure 27 shows the connection of a Trident Series meter to a PC using a PDA8006 Trident to USB Serial Adapter.

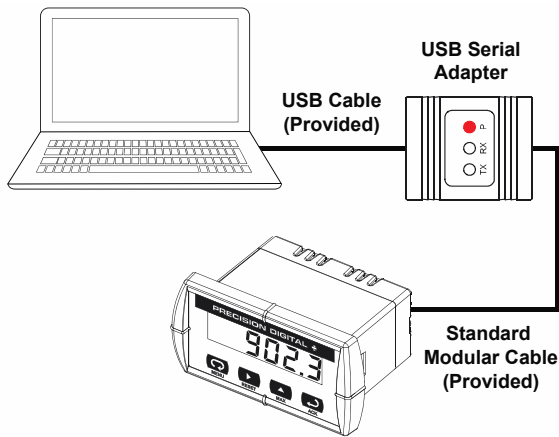

Figure 27. Trident USB Adapter Connections

Driver Download here:

[USB Drivers for PDA8006](#)

PDA8008 PROVu to USB Serial Adapter



Description

The PDA8008 PROVu to USB Serial Adapter allows for direct connection of a PROVu Series meter to the USB port of a PC. It is intended only for programming the meter when the meter is powered from AC or DC. Otherwise the USB cable provided with the meter can be used.

Installation

Figure 28 shows the connection of a PROVu Series meter to a PC using a PDA8008 PROVu to USB Serial Adapter.

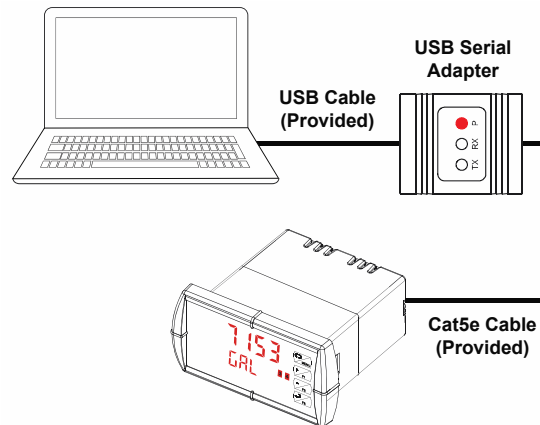

Figure 28. PROVu USB Adapter Connections

Driver Download here:

[USB Drivers for PDA8008](#)

PDA8232 USB to RS-232 Converter



Description

The PDA8232 USB to RS-232 Converter allows for direct connection of a serial device to the USB port of a PC.

Installation

Figure 29 shows the connection of a Trident meter to a PC using a PDA8232 USB to RS-232 Converter, PDA7232 RS-232 adapter, and the PDA7420 Modular Cable.

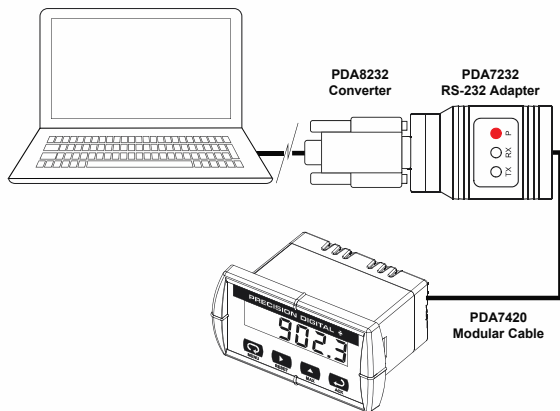

Figure 29. Connections for PDA8232 to serial device

Driver Download here:
[USB Drivers for PDA8232](#)

PDA8485 USB RS-485 Converter



Description

The PDA8485 converts USB to balanced, full or half-duplex RS-422 or RS-485 signals.

The PDA8485 has a removable screw terminal connector for the RS-485 terminals which includes Transmit Data (DO) and (/DO), Receive Data (DI) and (/DI), and Signal Ground.

Baud rates are automatic and handled by the PDA8485.

The PDA8485 has three diagnostic LEDs: a Power (P) LED to show when the converter is powered properly, a Transmit Data (TX) LED to show when the converter is sending data out from the PC side, and a Receive Data (RX) LED to show when the converter is receiving data from the network side.

The DIP switch SW1 is located inside the case and allows for system configurations.

Installation

The DIP switch SW1 allows for several different options. Factory settings for the switch are shown in Figure 30.

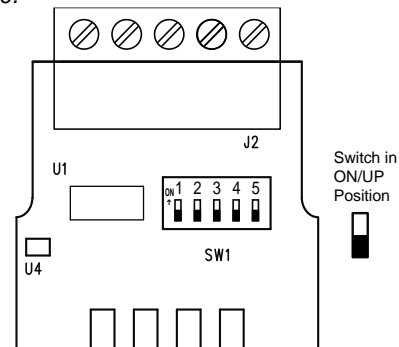

Figure 30. PDA8485 DIP Switch Location

The termination switch position adds an internal 120 ohm termination resistor when ON (up). Termination should be used on both ends of the network with high data rates and long wiring runs.

To configure a two-wire network set both of the 2-wire switch positions to ON (up). For a four-wire network set both of the 2-wire switches to OFF (down).

When the RS-422 switch position is ON (up) and the RS-485 switch position is OFF (down) it is configured for an RS-422 network. When the RS-422 switch position is OFF (down) and the RS-485 switch position is ON (up) it is configured for an RS-485 network.

PDA8485 DIP Switch Settings	
SW1 Switch Position	ON Setting Function
1	Network Termination Included (120 ohm)
2	2-Wire Network Mode Connection (factory setting)
3	2-Wire Network Mode Connection (factory setting)
4	RS-422 Mode
5	RS-485 Mode (factory setting)

Figure 31. PDA8485 DIP Switch Settings

Connections

The PDA8485 is powered by the USB port.

The PDA8485 can be configured for either a four-wire or two-wire network. *Figure 32* details the wiring connections from the PDA8485 to an RS-485 serial device in a four-wire network.

PDA8485 to RS-485 Serial Device Four-Wire Connections	
PDA8485 Serial Converter	RS-485 Serial Device
DO	DI
DO	DI
DI	DO
DI	DO

Figure 32. Connections for PDA8485 in a Four-Wire Network

Figure 33 details the wiring connections from the PDA8485 to an RS-485 serial device in a two-wire network when the DIP switches on the PDA8485 have been set to the “2-Wire Mode”.

PDA8485 to RS-485 Serial Device Two-Wire Connections	
PDA8485 Serial Converter	RS-485 Serial Device
DO	DATA
DO	DATA

Figure 33. Connections for PDA8485 in a Two-Wire Network

The PDA8485 internally connects the /DI to the /DO and the DI to the DO when the DIP switches are set to “2-Wire Mode”. Either the /DI or /DO could be used to connect to /DATA and either the DI or DO could be used to connect to DATA.

Figure 34 shows an example configuration of a two-wire network. Each device (e.g. Trident PD765 meter) connected to the same network must have a unique address.

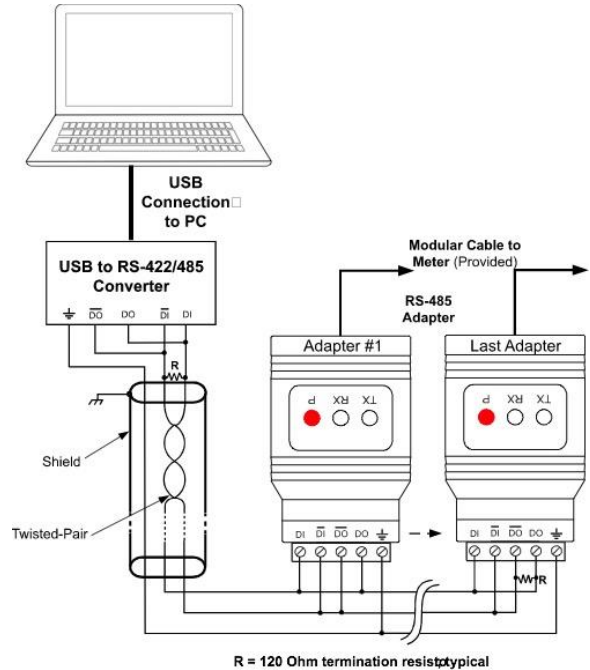

Figure 34. PDA8485 RS-485 Two-Wire Multi-Drop Wiring

Notes:

1. Termination resistors are optional and values depend on the cable length and characteristic impedance. Consult the cable manufacturer for recommendations.
2. Refer to *PDA7422 Trident RS-485 Serial Adapter* on page 12 for further details.
3. Use shielded cable, twisted-pair plus ground. Connect ground shield only at one location.

Driver Download here:
[USB Drivers for PDA8485](#)

Troubleshooting

Symptom	Check/Action
Power LED is off	PDA1232, PDA1485, PDA7232, or PDA7422 <ol style="list-style-type: none"> 1. Check modular cable connection 2. Check power to meter PDA7485 3. Check wall plug adapter output 4. Check power connection polarity PDA8485 5. Check USB connections 6. Try different USB port 7. Check USB port with other device
Meter not communicating with MeterView or other programs	Check: <ol style="list-style-type: none"> 1. Serial adapter and cable 2. Serial protocol selected 3. Meter address and baud rate 4. MeterView address and baud rate 5. DIP switch setting on the PDA7485 or PDA8485
If only the TX (or DATA IN) data status LED is flashing when serial communications attempted	Check: <ol style="list-style-type: none"> 1. Serial adapter and cable 2. Serial protocol selected 3. Meter address and baud rate 4. MeterView address and baud rate 5. DIP switch setting on the PDA7485 or PDA8485
If both data status LEDs (TX and RX) are off when trying to communicate	Remove all unnecessary cables and meters. Try getting the system to work with only one meter (to ease troubleshooting) and then expand the system one device at a time. PDA1232, PDA7232, or PDA7485: <ol style="list-style-type: none"> 1. Check serial cable 2. Connect the DB9 directly to the PC 3. Try a different serial port
Communications slow	Increase the baud rate
Random communication errors	<ol style="list-style-type: none"> 1. Increase the TX delay time 2. Decrease the baud rate
Other symptoms not described above	Call Technical Support for assistance.

Contact Precision Digital

Technical Support

Call: (800) 610-5239 or (508) 655-7300

Fax: (508) 655-8990

Email: support@predig.com

Sales Support

Call: (800) 343-1001 or (508) 655-7300

Fax: (508) 655-8990

Email: sales@predig.com

Place Orders

Email: orders@predig.com

For the latest version of this manual please visit

www.predig.com

PRECISION DIGITAL CORPORATION

233 South Street • Hopkinton MA 01748 USA

Tel (800) 343-1001 • Fax (508) 655-8990

www.predig.com

